



General Description

This product family offers state of the art performance. It is designed for high frequency applications here high efficiency and high reliability are required.

$V_R = 650\text{ V}$
 $I_F = 20\text{ A (}T_C=148^\circ\text{C)}$
 $Q_C = 44\text{ nC (}V_R=400\text{ V)}$

Features

- Zero Forward/Reverse Recovery Current
- High Blocking Voltage
- High Frequency Operation
- Positive Temperature Coefficient on VF
- Temperature Independent Switching Behavior

Benefits

- Higher System Efficiency
- Parallel Device Convenience without thermal runaway
- Higher Temperature Application
- No Switching loss
- Hard Switching & Higher Reliability
- Environmental Protection

Applications

- Motor Drives
- Solar Inverters
- AC/DC converters
- DC/DC converters
- Uninterruptable power supplies

Key performance parameters

Type	V_R	I_F $T_C=148^\circ\text{C}$	Q_C
LGE3D20065A	650V	20A	44nC

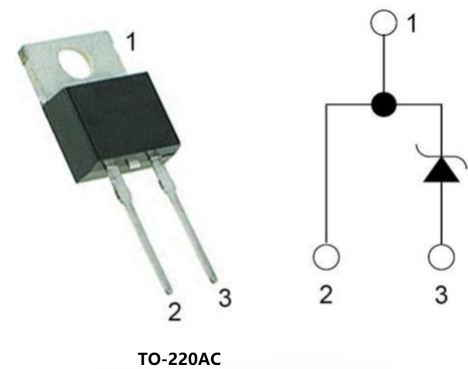

Caution: This device is sensitive to electrostatic discharge .Users should follow ESD handling procedures.



Maximum Ratings

$T_C=25^{\circ}\text{C}$, unless otherwise specified

Parameter	Symbol	Value	Unit
Peak Repetitive Reverse Voltage	V_{RRM}	650	V
Peak Reverse Surge Voltage	V_{RSM}	650	V
DC Blocking Voltage	V_R	650	V

Maximum Ratings

$T_C=25^{\circ}\text{C}$, unless otherwise specified

Parameter	Symbol	Value	Unit
Continuous Forward Current: $T_C = 25^{\circ}\text{C}$ $T_C = 135^{\circ}\text{C}$ $T_C = 148^{\circ}\text{C}$	I_F	58 25 20	A
Non Repetitive Forward Surge Current: $T_C = 25^{\circ}\text{C}$, $t_p = 10\text{ms}$, Half Sine Pulse $T_C = 110^{\circ}\text{C}$, $t_p = 10\text{ms}$, Half Sine Pulse	I_{FSM}	120 110	A
Repetitive peak Forward Surge Current: Freq = 0.1Hz, 100 cycles $T_C = 25^{\circ}\text{C}$, $t_p = 10\text{ms}$, Half Sine Pulse $T_C = 110^{\circ}\text{C}$, $t_p = 10\text{ms}$, Half Sine Pulse	I_{FRM}	110 100	A
Total power dissipation : $T_C = 25^{\circ}\text{C}$	P_D	176	W
Operating Junction Temperature :	T_J	-55 to 175	$^{\circ}\text{C}$
Storage Temperature :	T_{STG}	-55 to 175	$^{\circ}\text{C}$

Caution: This device is sensitive to electrostatic discharge .Users should follow ESD handling procedures.



Thermal Resistance

Parameter	Symbol	Typ.	Max	Unit
Thermal resistance, junction-case	R_{thJC}	0.85		$^{\circ}\text{C}/\text{W}$

Electrical Characteristic

$T_C = 25^{\circ}\text{C}$, unless otherwise specified

Parameter	Symbol	Value			Unit	Test Condition
		Min.	Typ.	Max.		
DC Blocking Voltage	V_{DC}	650			V	$I_R = 250\mu\text{A}$ $T_J = 25^{\circ}\text{C}$
Forward Voltage	V_F		1.50 1.60 1.70	1.80	V	$I_F = 20\text{A}$ $T_J = 25^{\circ}\text{C}$ $T_J = 125^{\circ}\text{C}$ $T_J = 175^{\circ}\text{C}$
Reverse Current	I_R		20 120 250	80	μA	$V_R = 650\text{V}$ $T_J = 25^{\circ}\text{C}$ $T_J = 125^{\circ}\text{C}$ $T_J = 175^{\circ}\text{C}$
Total Capacitance Charge	Q_C		44		nC	$V_R = 400\text{V}$ $T_J = 25^{\circ}\text{C}$
Total Capacitance	C		770 90 64		pF	$T_J = 25^{\circ}\text{C}$, Freq = 1MHz $V_R = 1\text{V}$ $V_R = 200\text{V}$ $V_R = 400\text{V}$

Caution: This device is sensitive to electrostatic discharge .Users should follow ESD handling procedures.



Characteristics Curves

Figure 1. Forward Characteristics

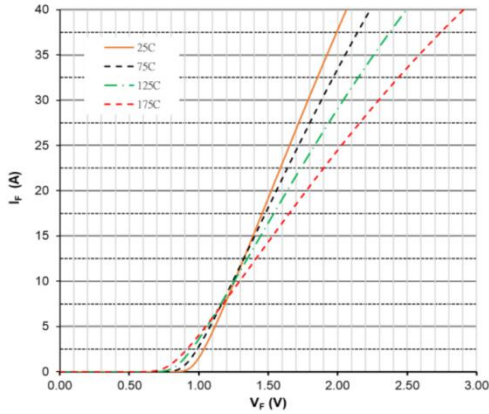

Figure 2. Forward Characteristics

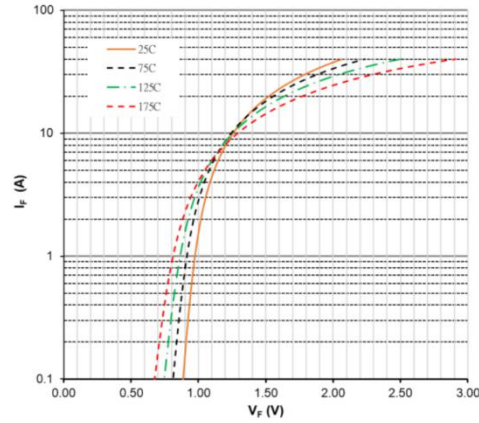

Figure 3. Reverse Characteristics

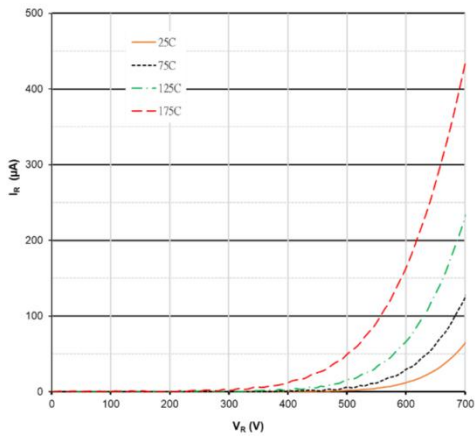

Figure 4. Power Derating

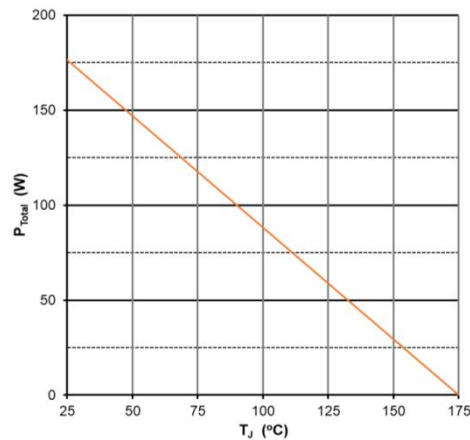

Figure 5. Capacitance vs Reverse Voltage

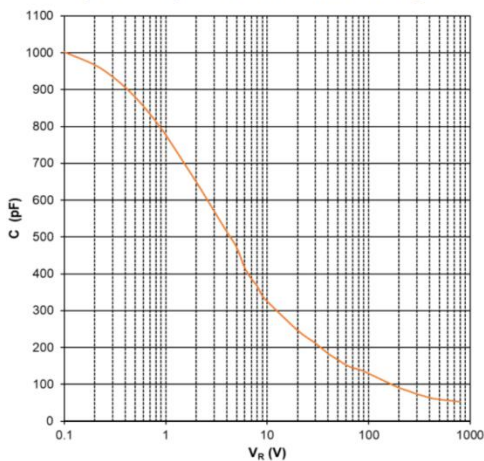
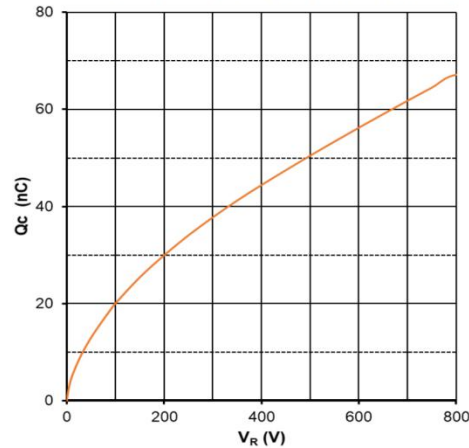

Figure 6. Recovery Charge vs Reverse Voltage



Caution: This device is sensitive to electrostatic discharge .Users should follow ESD handling procedures.

Package Outline: TO-220AC

COMMON DIMENSIONS

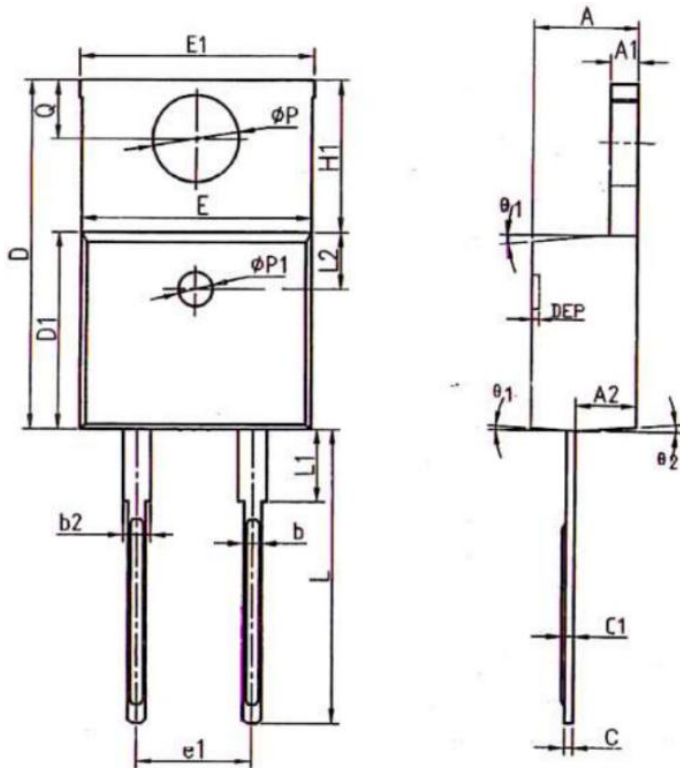

SYMBOL	MM			INCH		
	MIN	NOM	MAX	MIN	NOM	MAX
A	4.40	4.57	4.70	0.173	0.180	0.185
A1	1.22	1.27	1.32	0.048	0.050	0.052
A2	2.59	2.69	2.79	0.102	0.106	0.110
b	0.77	0.813	0.90	0.030	0.032	0.035
b2	1.20	1.27	1.36	0.047	0.050	0.054
c	0.34	0.381	0.47	0.013	0.015	0.019
c1	0.40	0.559	0.60	0.016	0.022	0.024
D	14.70	15.00	15.30	0.579	0.591	0.602
D1	8.60	8.70	8.80	0.339	0.343	0.346
E	10.06	10.16	10.26	0.396	0.400	0.404
E1	10.10	10.25	10.35	0.398	0.404	0.407
E2	10.00	10.10	10.20	0.394	0.398	0.402
e	2.54 BSC			0.100 BSC		
e1	5.08 BSC			0.200 BSC		
H1	6.10	6.30	6.50	0.240	0.248	0.256
L	13.20	13.40	13.50	0.520	0.528	0.531
L1	-	3.75	4.00	-	0.148	0.157
L2	2.50 REF			0.098 REF		
ϕP	3.76	3.84	3.88	0.148	0.151	0.153
Q	2.60	2.743	2.90	0.102	0.108	0.114
$\theta 1$	5°	7°	9°	5°	7°	9°
$\theta 2$	1°	3°	5°	1°	3°	5°
$\phi P1$	1.40	1.50	1.60	0.055	0.059	0.063
DEP	0.05	0.10	0.20	0.002	0.004	0.008

Package	Packing	Box Size LxWxH(mm)	Quantity(pcs/box)	Carton Size LxWxH(mm)	Quantity(pcs/carton)
TO-220	50pcs/Tube	558x148x38	1000	565x225x175	5000

Caution: This device is sensitive to electrostatic discharge .Users should follow ESD handling procedures.