

$V_R = 1700\text{ V}$
 $I_F = 20\text{ A (}T_C=150^\circ\text{C)}$
 $Q_C = 202\text{ nC (}V_R=1700\text{V)}$

Features

- Zero Forward/Reverse Recovery Current
- High Blocking Voltage
- High Frequency Operation
- Positive Temperature Coefficient on V_F
- Temperature Independent Switching Behavior
- High surge current capability
- 100% avalanche tested

Benefits

- Higher System Efficiency
- Parallel Device Convenience without thermal runaway
- Higher Temperature Application
- No Switching loss
- Hard Switching & Higher Reliability
- Environmental Protection

Applications

- Motor Drives
- Solar / Wind Inverters
- AC/DC converters
- DC/DC converters
- Uninterruptable power supplies

TO-247-2

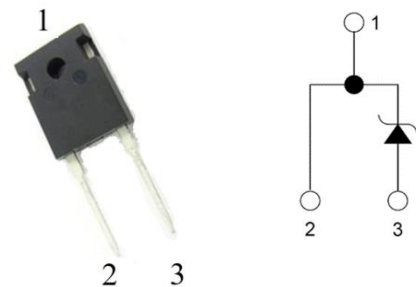

Maximum Ratings ($T_C=25^\circ\text{C}$ unless otherwise specified)

Parameter	Symbol	Test conditions	Value	Unit
Peak Repetitive Reverse Voltage	V_{RRM}		1700	V
Continuous Forward Current	I_F	$T_C=25^\circ\text{C}$	54	A
		$T_C=135^\circ\text{C}$	26	
		$T_C=150^\circ\text{C}$	20	
Non repetitive Forward Surge Current	I_{FSM}	$T_C = 25^\circ\text{C}$, $t_p=10\text{ ms}$, Half Sine Pulse	205	A
		$T_C = 110^\circ\text{C}$, $t_p=10\text{ ms}$, Half Sine Pulse	190	
Repetitive peak Forward Surge Current	I_{FRM}	$T_C = 25^\circ\text{C}$, $t_p=10\text{ ms}$, Freq = 0.1Hz, 100 cycles, Half Sine Pulse	155	A
		$T_C = 110^\circ\text{C}$, $t_p=10\text{ ms}$, Freq = 0.1Hz, 100 cycles, Half Sine Pulse	140	
Total power dissipation	P_D	$T_C=25^\circ\text{C}$	333	W
		$T_C=110^\circ\text{C}$	144	
Operating Junction Temperature	T_J		-55 to 175	$^\circ\text{C}$
Storage Temperature	T_{STG}		-55 to 175	$^\circ\text{C}$



Electrical Characteristics

Parameter	Symbol	Test conditions	Min	Typ	Max	Unit
DC Blocking Voltage	V_{DC}	$T_J = 25^{\circ}C$	1700			V
Forward Voltage	V_F	$I_F = 20A, T_J = 25^{\circ}C$		1.45	1.75	V
		$I_F = 20A, T_J = 125^{\circ}C$		1.9		
		$I_F = 20A, T_J = 175^{\circ}C$		2.3		
Reverse Current	I_R	$V_R = 1700V, T_J = 25^{\circ}C$		2	150	uA
		$V_R = 1700V, T_J = 125^{\circ}C$		12		
		$V_R = 1700V, T_J = 175^{\circ}C$		50		
Total Capacitive Charge	Q_C	$V_R = 1700V, T_J = 25^{\circ}C$		202		nC
Total Capacitance	C	$V_R = 1V, T_J = 25^{\circ}C,$ Freq = 1MHz		1415		pF
		$V_R = 800V, T_J = 25^{\circ}C,$ Freq = 1MHz		89		
		$V_R = 1200V, T_J = 25^{\circ}C,$ Freq = 1MHz		83		
		$V_R = 1700V, T_J = 25^{\circ}C,$ Freq = 1MHz		79		

Note: This is a majority carrier diode, so there is no reverse recovery charge

Thermal Characteristics

Parameter	Symbol	Condition	Min	Typ	Max	Unit
Thermal Resistance	$R_{th(j-c)}$	junction-case		0.45		$^{\circ}C/W$

Typical Electrical Curves

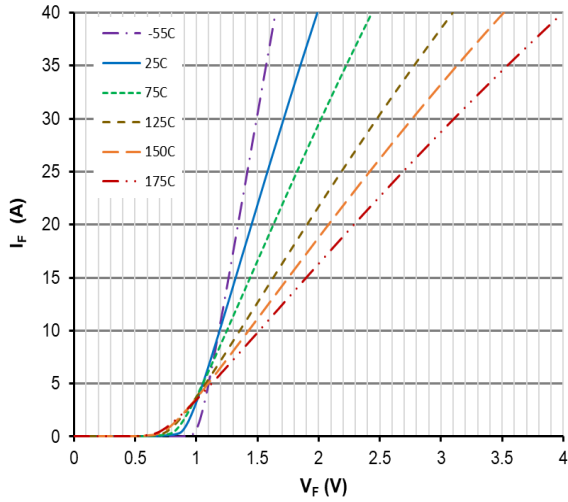

Figure 1. Forward Characteristics

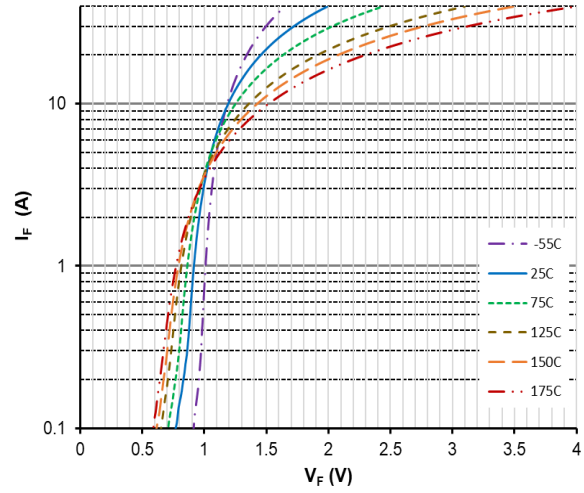

Figure 2. Forward Characteristics

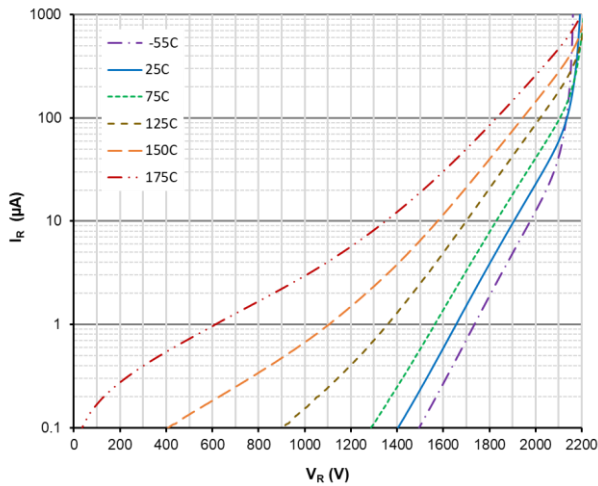

Figure 3. Reverse Characteristics

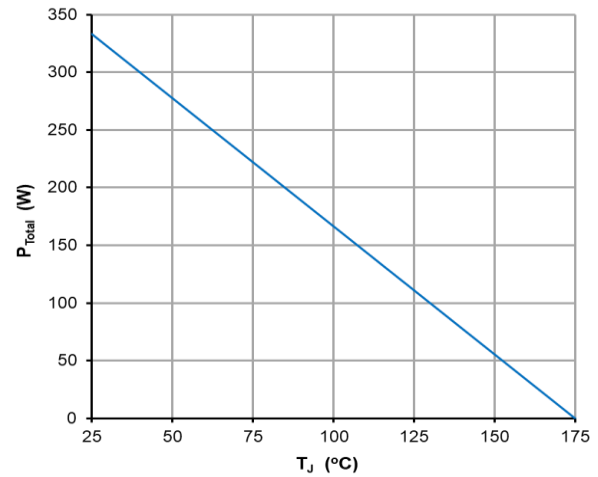

Figure 4. Power Derating

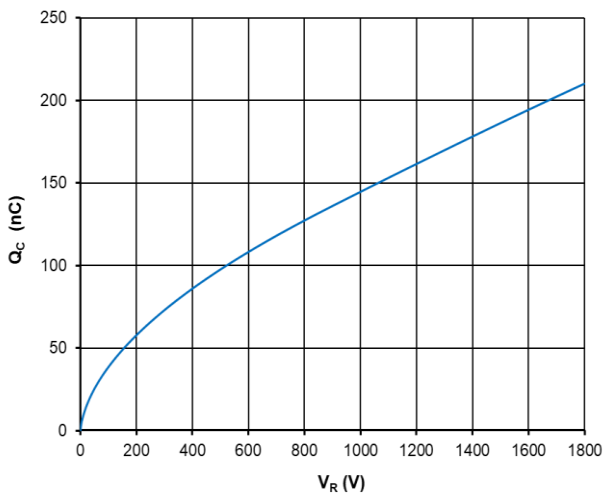

Figure 5. Reverse charge vs. Reverse Voltage

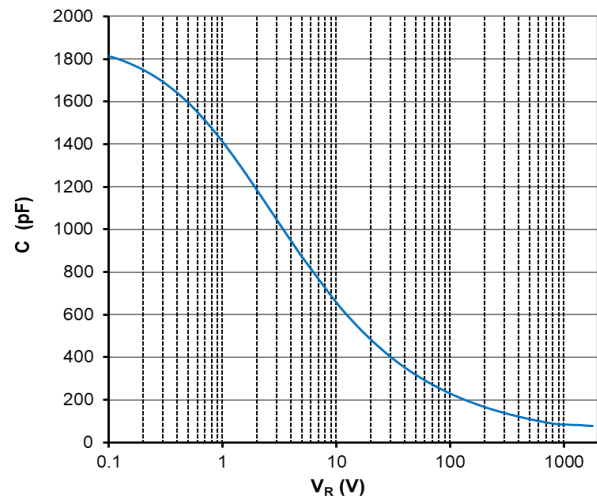

Figure 6. Capacitance vs. Reverse Voltage

Typical Electrical Curves

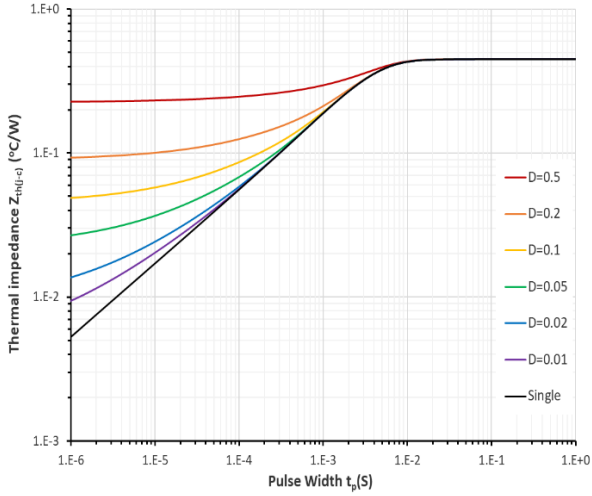

Figure 7. Transient Thermal Impedance

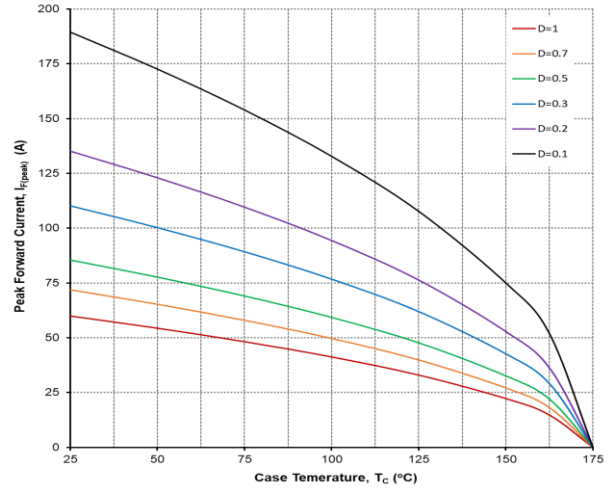
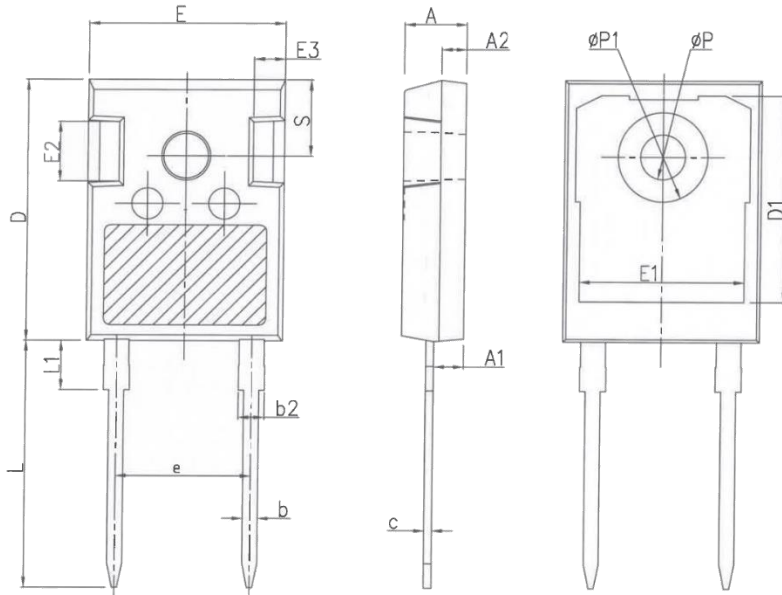

Figure 8. Current Derating

Package Dimensions

(TO-247-2 Package)



SYMBOL	mm	
	MIN.	MAX
A	4.8	5.20
A1	2.21	2.59
A2	1.85	2.15
b	1.11	1.36
b2	1.91	2.21
c	0.51	0.75
D	20.70	21.30
D1	16.25	16.85
E	15.50	16.10
E1	13.00	13.60
E2	4.80	5.20
E3	2.30	2.70
e	10.88BSC	
L	19.62	20.22
L1	-	4.30
ϕP	3.4	3.80
$\phi P1$	-	7.30
S	6.15BSC	

Part Number	Package	Packing	Marking
LGE3D20170H	TO-247-2	30pcs / Tube	LGE3D20170H