

V_Z : 2.4 to 75 V

P_D : 300 mW

Features

- ✧ Steady State Power Rating of 300 mW
- ✧ Standard Zener Breakdown Voltage Range 2.4V to 75V
- ✧ Pb / RoHS Free

Mechanical Data

- ✧ LEAD FINISH : 100% Matte Sn (Tin)
- ✧ MOUNTING POSITION : Any
- ✧ QUALIFIED MAX REFLOW TEMPERATURE : 260 °C

SOD-523

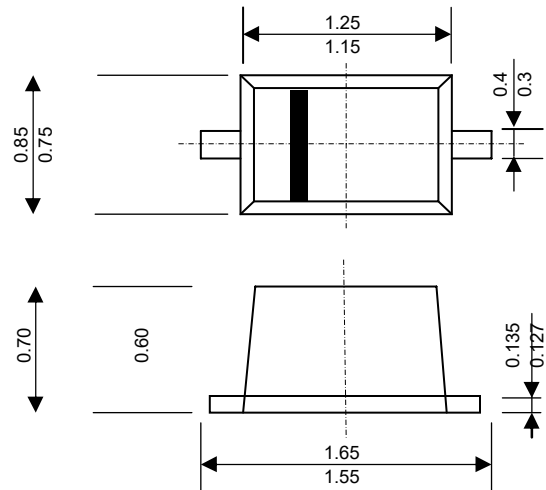

Dimensions in millimeters

Maximum Ratings and Thermal Characteristics

Parameter	Symbol	Value	Unit
Total Device Dissipation FR-5 Board, at Ta = 25 °C	P_D	300	mW
Junction Temperature Range	T_J	-65 to + 150	°C
Storage Temperature Range	T_{STG}	-65 to + 150	°C



ELECTRICAL CHARACTERISTICS

(Ta=25 °C unless otherwise noted, V_F = 0.9 V Max. @ I_F =10 mA for all types)

Part No.	Marking Code	Zener Voltage (Note 1)			Test Current	Zener Impedance		Test Current	Leakage Current		∅V _Z (mV/k) @ I _{ZT}		C @ V _R =0 f = 1MHz
		V _Z @ I _{ZT} (V)			I _{ZT}	Z _{ZT} @ I _{ZT}	Z _{ZT} @ I _{ZK}	I _{ZK}	I _R @ V	Min.	Max.	pF	
		Min.	Nom.	Max.	(mA)	(Ω)	(Ω)	(mA)	(μA)	(V)			
MM5Z2V4	00	2.2	2.4	2.6	5	100	1000	1.0	50	1.0	-3.5	0	450
MM5Z2V7	01	2.5	2.7	2.9	5	100	1000	1.0	20	1.0	-3.5	0	450
MM5Z3V0	02	2.8	3.0	3.2	5	100	1000	1.0	10	1.0	-3.5	0	450
MM5Z3V3	05	3.1	3.3	3.5	5	95	1000	1.0	5	1.0	-3.5	0	450
MM5Z3V6	06	3.4	3.6	3.8	5	90	1000	1.0	5	1.0	-3.5	0	450
MM5Z3V9	07	3.7	3.9	4.1	5	90	1000	1.0	3	1.0	-3.5	-2.5	450
MM5Z4V3	08	4.0	4.3	4.6	5	90	1000	1.0	3	1.0	-3.5	0	450
MM5Z4V7	09	4.4	4.7	5.0	5	80	800	1.0	3	2.0	-3.5	0.2	260
MM5Z5V1	0A	4.8	5.1	5.4	5	60	500	1.0	2	2.0	-2.7	1.2	225
MM5Z5V6	0C	5.2	5.6	6.0	5	40	200	1.0	1	2.0	-2.0	2.5	200
MM5Z6V2	0E	5.8	6.2	6.6	5	10	100	1.0	3	4.0	0.4	3.7	185
MM5Z6V8	0F	6.4	6.8	7.2	5	15	160	1.0	2	4.0	1.2	4.5	155
MM5Z7V5	0G	7.0	7.5	7.9	5	15	160	1.0	1	5.0	2.5	5.3	140
MM5Z8V2	0H	7.7	8.2	8.7	5	15	160	1.0	0.7	5.0	3.2	6.2	135
MM5Z9V1	0K	8.5	9.1	9.6	5	15	160	1.0	0.2	7.0	3.8	7.0	130
MM5Z10V	0L	9.4	10	10.6	5	20	160	1.0	0.1	8.0	4.5	8.0	130
MM5Z11V	0M	10.4	11	11.6	5	20	160	1.0	0.1	8.0	5.4	9.0	130
MM5Z12V	0N	11.4	12	12.7	5	25	80	1.0	0.1	8.0	6.0	10.0	130
MM5Z13V	0P	12.4	13.25	14.1	5	30	80	1.0	0.1	8.0	7.0	11.0	120
MM5Z15V	0T	14.3	15	15.8	5	30	80	1.0	0.05	10.5	9.2	13.0	110
MM5Z16V	0U	15.3	16.2	17.1	5	40	80	1.0	0.05	11.2	10.4	14.0	105
MM5Z18V	0W	16.8	18	19.1	5	45	80	1.0	0.05	12.6	12.4	16.0	100
MM5Z20V	0Z	18.8	20	21.2	5	55	100	1.0	0.05	14.0	14.4	18.0	85
MM5Z22V	10	20.8	22	23.3	5	55	100	1.0	0.05	15.4	15.4	20.0	85
MM5Z24V	11	22.8	24.2	25.6	5	70	120	1.0	0.05	16.8	18.4	22.0	80
MM5Z27V	12	25.1	27	28.9	2	80	300	1.0	0.05	18.9	21.4	25.3	70
MM5Z30V	14	28	30	32	2	80	300	1.0	0.05	21.0	24.4	29.4	70
MM5Z33V	18	31	33	35	2	80	300	1.0	0.05	23.2	27.4	33.4	70
MM5Z36V	19	34	36	38	2	90	500	1.0	0.05	25.2	30.4	37.4	70
MM5Z39V	20	37	39	41	2	130	500	1.0	0.05	27.3	33.4	41.2	45
MM5Z43V	21	40	43	46	2	150	500	1.0	0.05	30.1	37.6	46.6	40
MM5Z47V	1A	44	47	50	2	170	500	1.0	0.05	32.9	42.0	51.8	40
MM5Z51V	1C	48	51	54	2	180	500	1.0	0.05	35.7	46.6	57.2	40
MM5Z56V	1D	52	56	60	2	200	500	1.0	0.05	39.2	52.2	63.8	40
MM5Z62V	1E	58	62	66	2	215	500	1.0	0.05	43.4	58.8	71.6	35
MM5Z68V	1F	64	68	72	2	240	500	1.0	0.05	47.6	65.6	79.8	35
MM5Z75V	1G	70	75	79	2	255	500	1.0	0.05	52.5	73.4	88.6	35

Note :

(1) Zener voltage is measured with a pulse test current I_Z at an ambient temperature of 25

°C.



Typical Characteristics

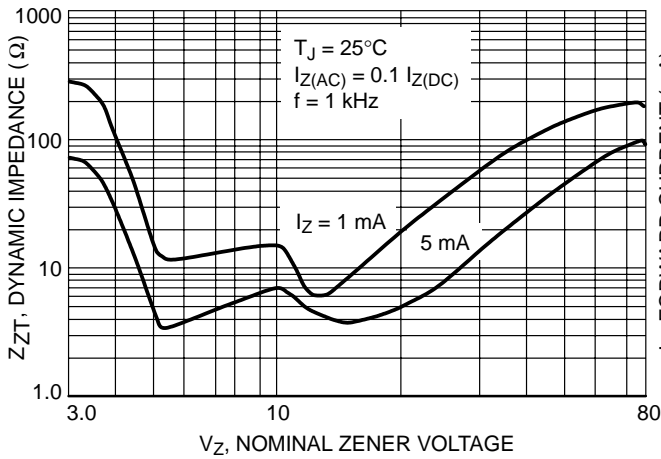

Figure 1. Effect of Zener Voltage on Zener Impedance

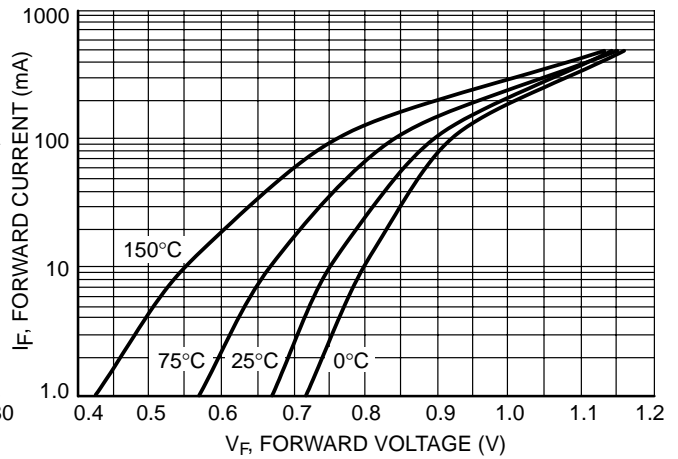

Figure 2. Typical Forward Voltage

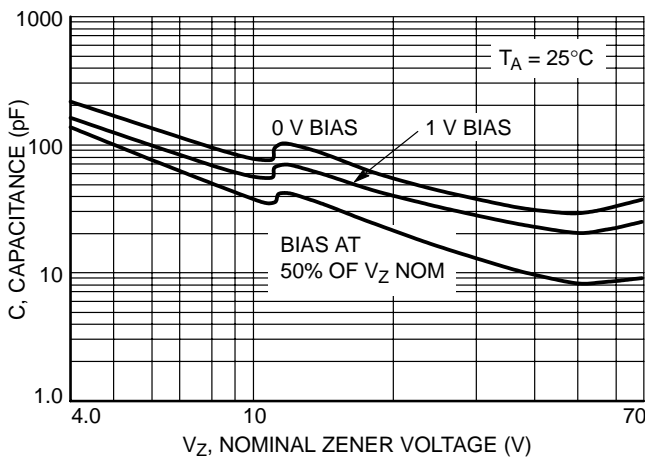

Figure 3. Typical Capacitance

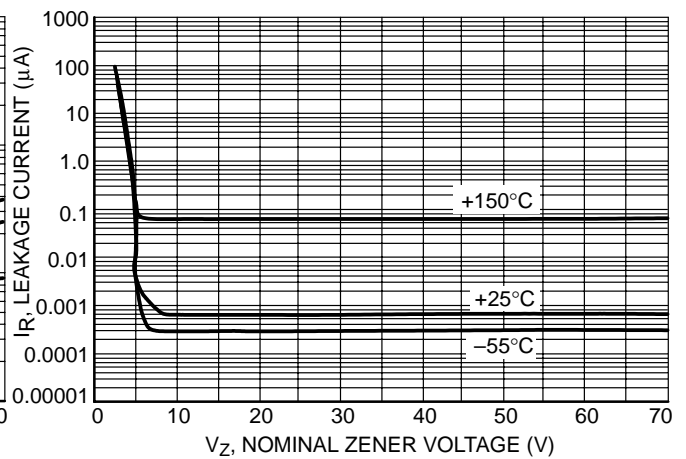
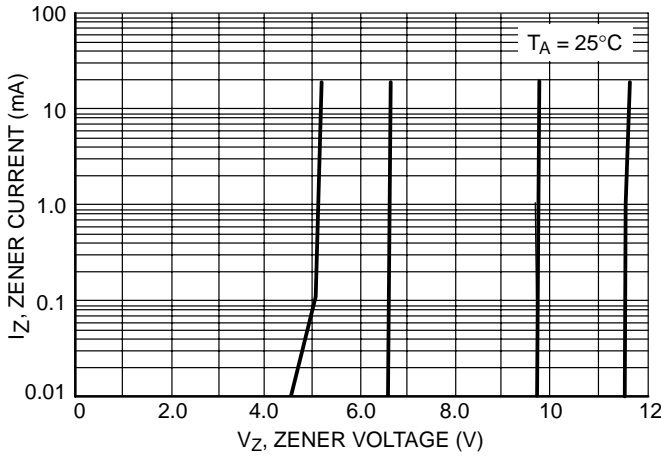

Figure 4. Typical Leakage Current



Typical Characteristics



**Figure 5. Zener Voltage versus Zener Current
(V_Z Up to 12 V)**

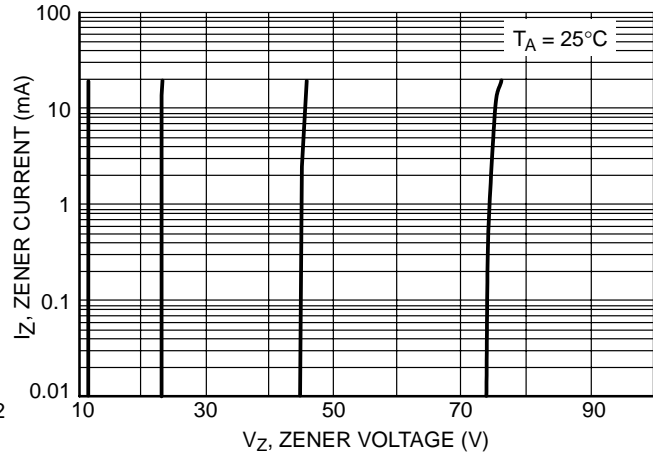

**Figure 6. Zener Voltage versus Zener Current
(12 V to 75 V)**

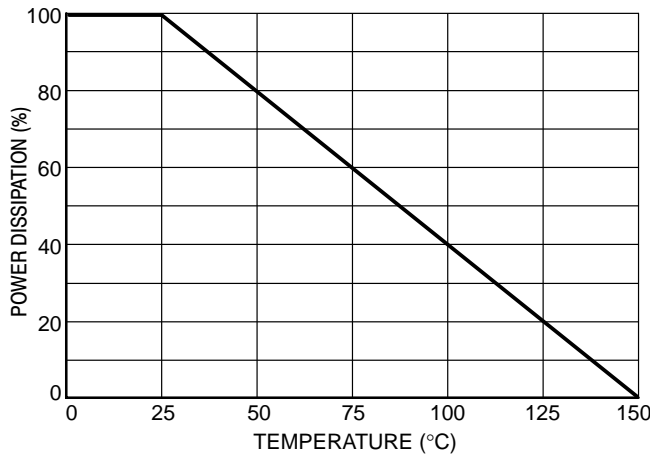

Figure 7. Steady State Power Derating

PACKAGE INFORMATION

Part Number	Package	Shipping Quantity
MM5Z2V4 -MM5Z745V	SOD-523	3000pcs / Tape & Reel