

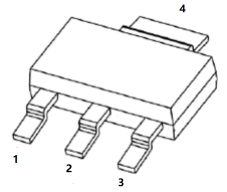

### SOT-223



1. BASE
2. COLLECTOR
3. EMITTER

### FEATURES

- Complementary to CZT127
- Silicon Power Darlington Transistors
- Low speed switching and amplifier applications

### Equivalent Circuit

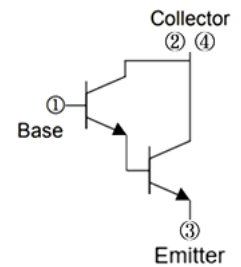

### MAXIMUM RATINGS (T<sub>a</sub>=25°C unless otherwise noted)

Symbol	Parameter	Value	Unit
V <sub>CB0</sub>	Collector-Base Voltage	100	V
V <sub>CEO</sub>	Collector-Emitter Voltage	100	V
V <sub>EBO</sub>	Emitter-Base Voltage	5	V
I <sub>C</sub>	Collector Current -Continuous	5	A
P <sub>C</sub>	Collector Power Dissipation	1	W
T <sub>J</sub> , T <sub>stg</sub>	Operation Junction and Storage Temperature Range	-55~150	°C

### ELECTRICAL CHARACTERISTICS (T<sub>a</sub>=25°C unless otherwise specified)

Parameter	Symbol	Test conditions	Min	Typ	Max	Unit
Collector-base breakdown voltage	V <sub>(BR)CBO</sub>	I <sub>C</sub> =1mA, I <sub>E</sub> =0	100			V
Collector-emitter breakdown voltage	V <sub>(BR)CEO</sub>	I <sub>C</sub> =30mA, I <sub>B</sub> =0	100			V
Collector cut-off current	I <sub>CBO</sub>	V <sub>CB</sub> =100V, I <sub>E</sub> =0			200	uA
Base cut-off current	I <sub>CEO</sub>	V <sub>CE</sub> =50V, I <sub>B</sub> =0			500	uA
Emitter cut-off current	I <sub>EBO</sub>	V <sub>EB</sub> =5V, I <sub>C</sub> =0			2	mA
DC current gain	h <sub>FE(1)</sub>	V <sub>CE</sub> =3V, I <sub>C</sub> =0.5A	1000			
	h <sub>FE(2)</sub>	V <sub>CE</sub> =3V, I <sub>C</sub> =3A	1000			
Collector-emitter saturation voltage	V <sub>CE(sat)1</sub>	I <sub>C</sub> =3A, I <sub>B</sub> =12mA			2	V
	V <sub>CE(sat)2</sub>	I <sub>C</sub> =5A, I <sub>B</sub> =20mA			4	V
Base-emitter voltage	V <sub>BE(on)</sub>	V <sub>CE</sub> =3V, I <sub>C</sub> =3A			2.5	V
Transition frequency	f <sub>T</sub>	V <sub>CE</sub> =4V, I <sub>C</sub> =3A, f=1MHz	4			MHz
Collector output capacitance	C <sub>ob</sub>	V <sub>CB</sub> =10V, I <sub>E</sub> =0, f=1.0MHz			200	pF



### Typical Characteristics

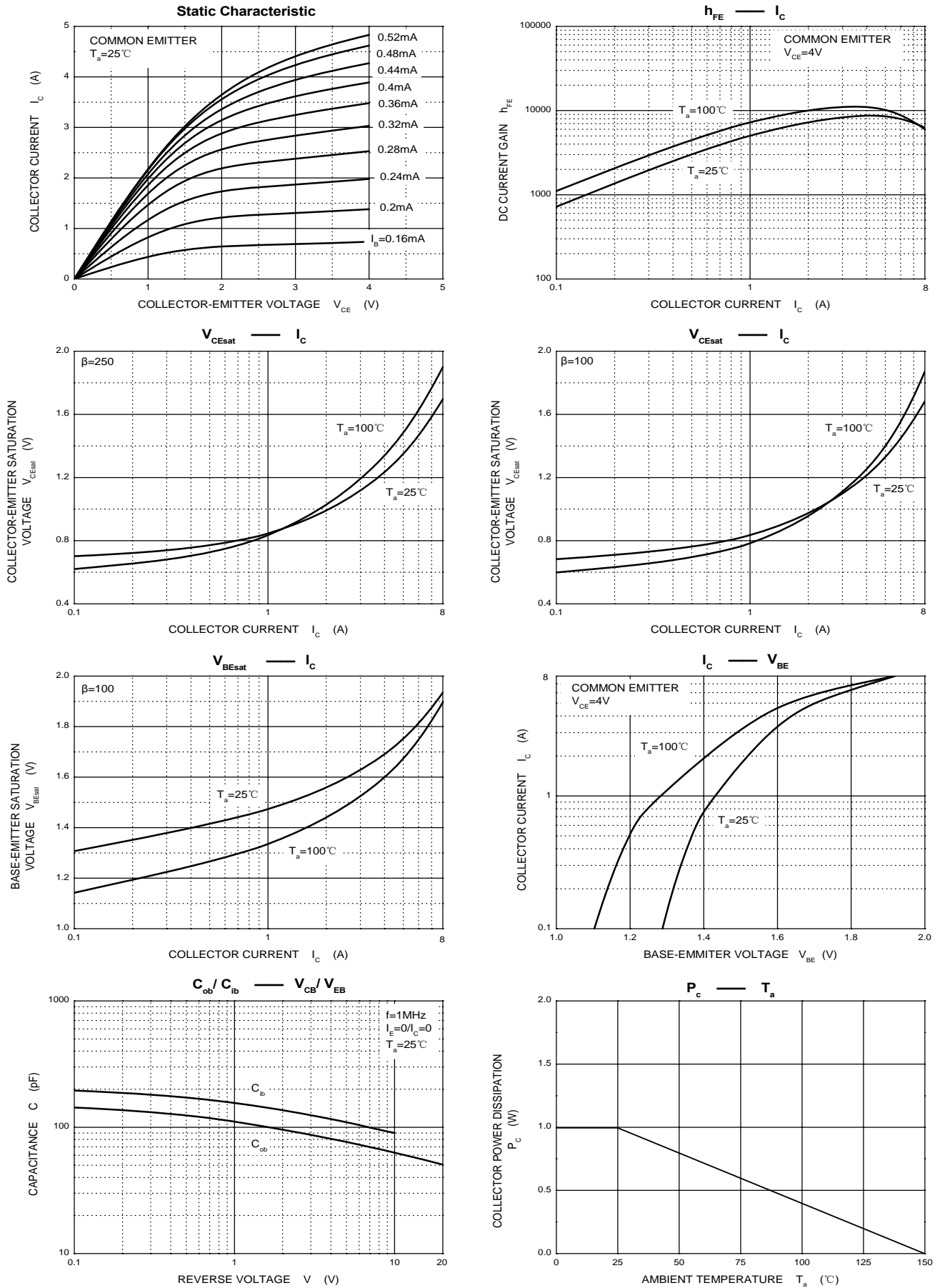



### SOT-223 Package Outline Dimensions

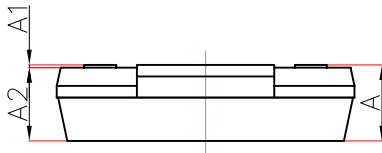
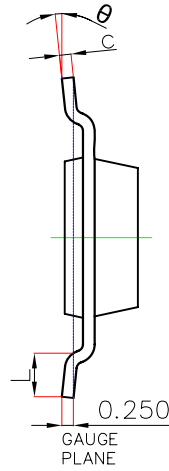
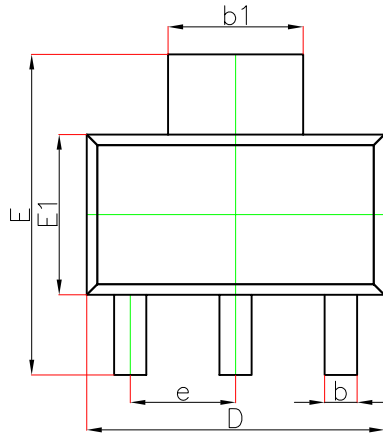

Symbol	Dimensions In Millimeters		Dimensions In Inches	
	Min.	Max.	Min.	Max.
A	—	1.800	—	0.071
A1	0.020	0.100	0.001	0.004
A2	1.500	1.700	0.059	0.067
b	0.660	0.840	0.026	0.033
b1	2.900	3.100	0.114	0.122
c	0.230	0.350	0.009	0.014
D	6.300	6.700	0.248	0.264
E	6.700	7.300	0.264	0.287
E1	3.300	3.700	0.130	0.146
e	2.300(BSC)		0.091(BSC)	
L	0.750	—	0.030	—
theta	0°	10°	0°	10°

### SOT-223 Suggested Pad Layout

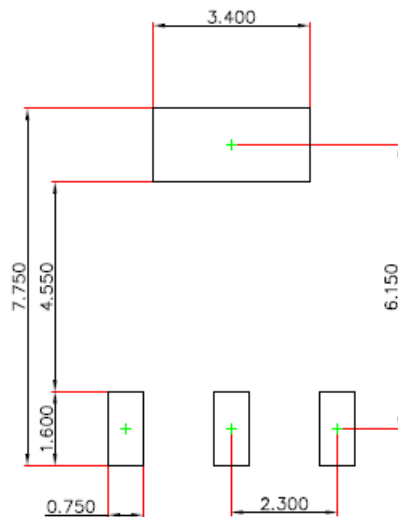

#### Note:

1. Controlling dimension: in millimeters.
2. General tolerance:  $\pm 0.050$ mm.
3. The pad layout is for reference purposes only.



### SOT-223 Tape and Reel

#### SOT-223 Embossed Carrier Tape

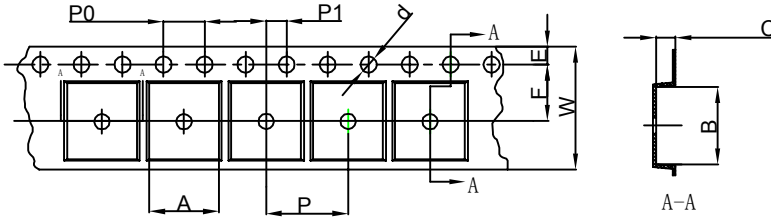

**Packaging Description:**

SOT-223 parts are shipped in tape. The carrier tape is made from a dissipative (carbon filled) polycarbonate resin. The cover tape is a multilayer film (Heat Activated Adhesive in nature) primarily composed of polyester film, adhesive layer, sealant, and anti-static sprayed agent. These reeled parts in standard option are shipped with 2,500 units per 13" or 33.0cm diameter reel. The reels are clear in color and is made of polystyrene plastic (anti-static coated).

Dimensions are in millimeter										
Pkg type	A	B	C	d	E	F	P0	P	P1	W
SOT-223	6.765	7.335	1.88	Ø1.50	1.75	5.50	4.00	8.00	2.00	12.00

#### SOT-223 Tape Leader and Trailer

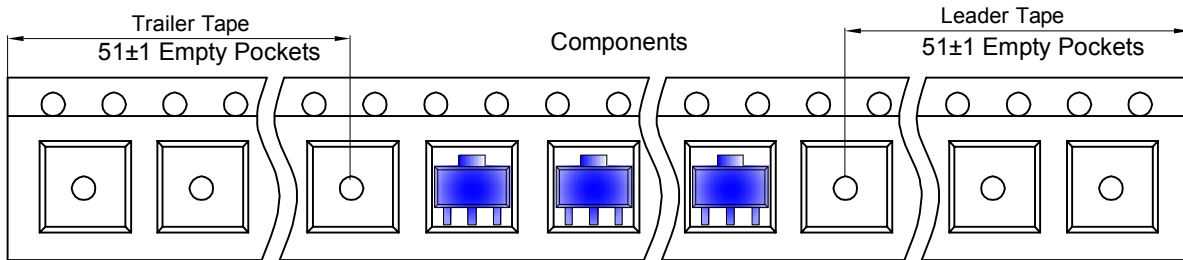

#### SOT-223 Reel

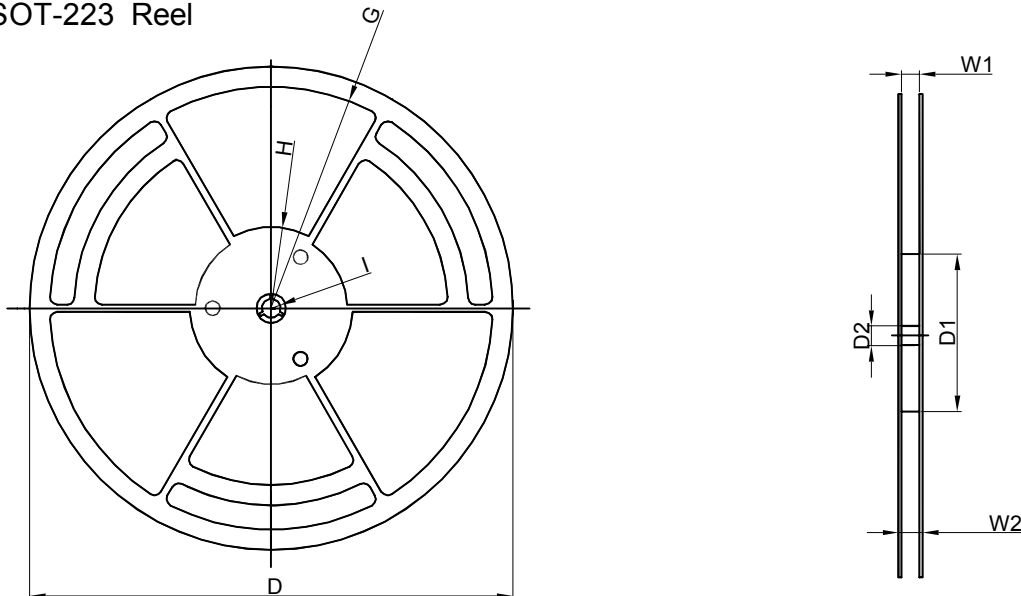

Dimensions are in millimeter								
Reel Option	D	D1	D2	G	H	I	W1	W2
13" Dia	Ø330.00	100.00	13.00	R151.00	R56.00	R6.50	12.40	17.60

REEL	Reel Size	Box	Box Size(mm)	Carton	Carton Size(mm)	G.W.(kg)
2,500 pcs	13 inch	2,500 pcs	336×336×48	20,000 pcs	445×355×365	