

1. BASE
2. COLLECTOR
3. EMITTER

TO-220

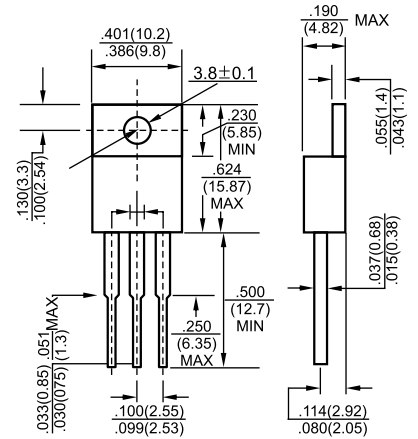

Dimensions in inches and (millimeters)

Features

- ✧ High DC Current Gain : $h_{FE}=1000$ @ $V_{CE}=4V, I_C=1A$ (Min.)
- ✧ Low Collector-Emitter Saturation Voltage
- ✧ Industrial Use

MAXIMUM RATINGS ($T_A=25^\circ C$ unless otherwise noted)

Symbol	Parameter	Value	Units
V_{CBO}	Collector-Base Voltage	80	V
V_{CEO}	Collector-Emitter Voltage	80	V
V_{EBO}	Emitter-Base Voltage	5	V
I_C	Collector Current -Continuous	2	A
P_C	Collector Dissipation	2	W
T_J	Junction Temperature	150	$^\circ C$
T_{stg}	Storage Temperature	-55 to +150	$^\circ C$

Equivalent Circuit

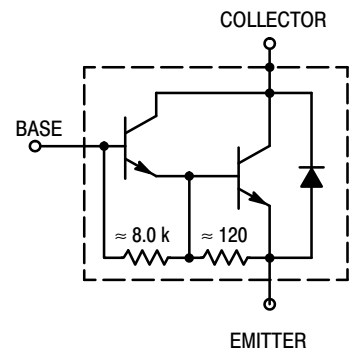

ELECTRICAL CHARACTERISTICS ($T_{amb}=25^\circ C$ unless otherwise specified)

Parameter	Symbol	Test conditions	MIN	TYP	MAX	UNIT
Collector-base breakdown voltage	$V_{(BR)CBO}$	$I_C=10mA, I_E=0$	80			V
Collector-emitter sustaining voltage	$V_{CEO}^{(sus)}$	$I_C=30mA, I_B=0$	80			V
Emitter-base breakdown voltage	$V_{(BR)EBO}$	$I_E=10mA, I_C=0$	5			V
Collector cut-off current	I_{CEO}	$V_{CE}=40V, I_B=0$			2	mA
Collector cut-off current	I_{CBO}	$V_{CB}=80V, I_E=0$			1	mA
Emitter cut-off current	I_{EBO}	$V_{EB}=5V, I_C=0$			2	mA
DC current gain	$h_{FE(1)}$	$V_{CE}=4V, I_C=1A$	1000			
	$h_{FE(2)}$	$V_{CE}=4V, I_C=2A$	500			
Collector-emitter saturation voltage	$V_{CE(sat)}$	$I_C=2A, I_B=8mA$			2.5	V
Base-emitter voltage	V_{BE}	$V_{CE}=4V, I_C=2A$			2.8	V
Collector output capacitance	C_{ob}	$V_{CB}=10V, I_E=0, f=0.1MHz$			100	pF



Typical Characteristics

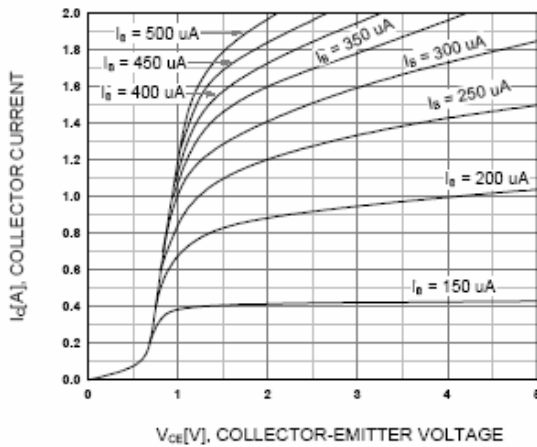

Figure 1. Static Characteristic

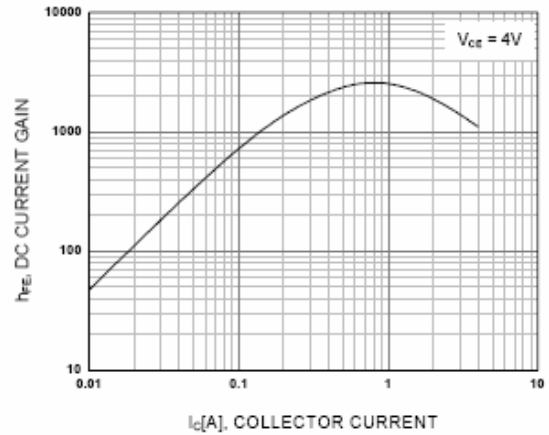

Figure 2. DC current Gain

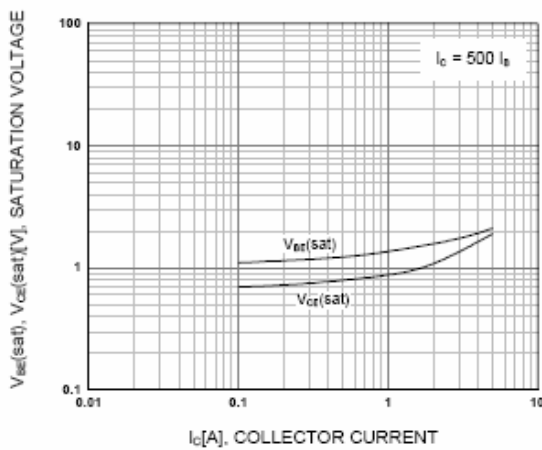

Figure 3. Base-Emitter Saturation Voltage
Collector-Emmitter Saturation Voltage

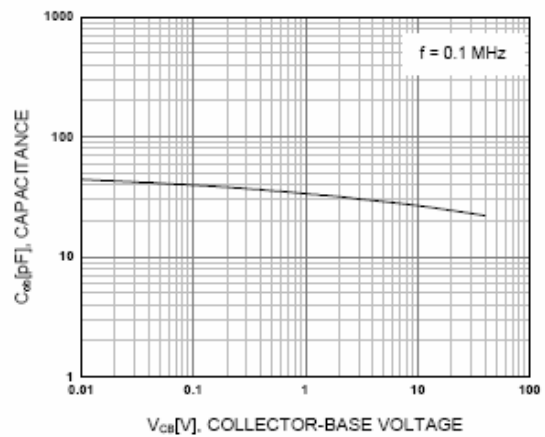

Figure 4. Collector Output Capacitance

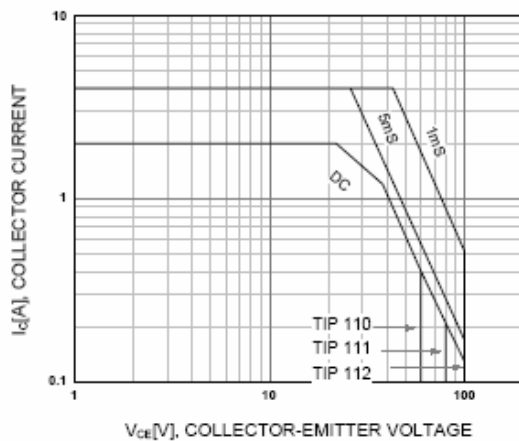

Figure 5. Safe Operating Area

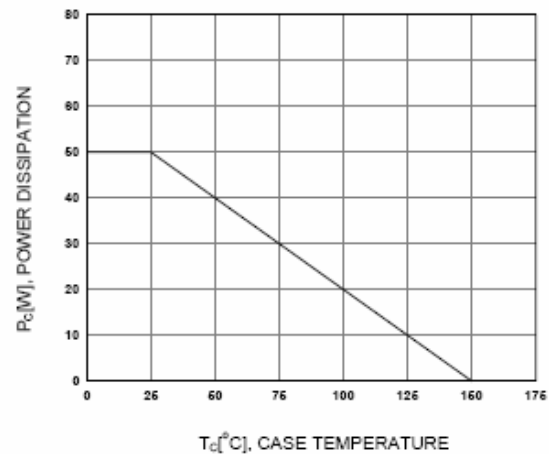

Figure 6. Power Derating