



Features

- DTA114Y and DTC144E transistors are built-in a package
- Ideal for power switch circuits
- Mounting cost and area can be cut in half

Mechanical Data

- Case: SOT-353
- Molding Compound: UL Flammability Classification Rating 94V-0
- Terminals: Matte tin-plated leads; solderability-per MIL-STD-202, Method 208

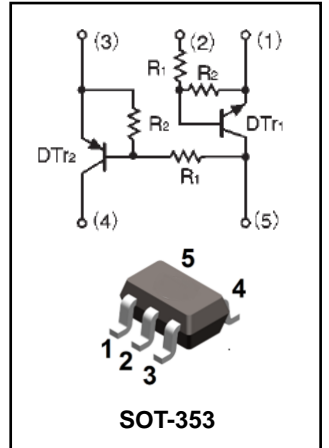

Ordering Information

Part Number	Package	Shipping Quantity	Marking Code
UMC4N	SOT-353	3000 pcs / Tape & Reel	C4

Maximum Ratings (@ T_A = 25°C unless otherwise specified)

Symbol	Parameter	Value		Unit
		DTr1	DTr2	
V _{CC}	Supply Voltage	50	-50	V
V _{IN}	Input Voltage	-10 to +40	+6 to -40	V
I _O	Output Current	100	-70	mA
I _{CM}	Output Current	100	-100	mA

Thermal Characteristics

Parameter	Symbol	Value	Unit
Power Dissipation	P _D	150	mW
Operating Junction Temperature Range	T _J	-55 ~ +150	°C
Storage Temperature Range	T _{STG}	-55 ~ +150	°C



Electrical Characteristics-DTR1 (@ T_A = 25°C unless otherwise specified)

Parameter	Symbol	Test Condition	Min.	Typ.	Max.	Unit
Input Voltage	V _{I(off)}	V _{CC} = 5V, I _O = 100μA	0.5	-	-	V
	V _{I(on)}	V _O = 0.3V, I _O = 2mA	-	-	3	V
Output Voltage	V _{O(on)}	I _O = 10mA, I _I = 0.5mA	-	-	0.3	V
Input Current	I _I	V _I = 5V	-	-	0.18	mA
Output Current	I _{O(off)}	V _{CC} = 50V, V _I = 0V	-	-	0.5	μA
DC Current Gain	G _I	V _O = 5V, I _O = 5mA	68	-	-	-
Input Resistor	R ₁		32.9	47	61.1	kΩ
Resistance ratio	R ₂ /R ₁		0.8	1	1.2	
Gain-Bandwidth Product	f _T	V _{CE} = 10V, I _E = -5mA, f = 100MHz	-	250	-	MHz

Electrical Characteristics-DTR2 (@ T_A = 25°C unless otherwise specified)

Parameter	Symbol	Test Condition	Min.	Typ.	Max.	Unit
Input Voltage	V _{I(off)}	V _{CC} = -5V, I _O = -100μA	-0.3	-	-	V
	V _{I(on)}	V _O = -0.3V, I _O = -1mA	-	-	-1.4	V
Output Voltage	V _{O(on)}	I _O = -5mA, I _I = -0.25mA	-	-	-0.3	V
Input Current	I _I	V _I = -5V	-	-	-0.88	mA
Output Current	I _{O(off)}	V _{CC} = -50V, V _I = 0V	-	-	-0.5	μA
DC Current Gain	G _I	V _O = -5V, I _O = -10mA	68	-	-	-
Input Resistor	R ₁		7	10	13	kΩ
Resistance ratio	R ₂ /R ₁		3.7	4.7	5.7	
Gain-Bandwidth Product	f _T	V _{CE} = -10V, I _E = 5mA, f = 100MHz	-	250	-	MHz

Ratings and Characteristic Curves-DTR1 (@ T_A = 25°C unless otherwise specified)

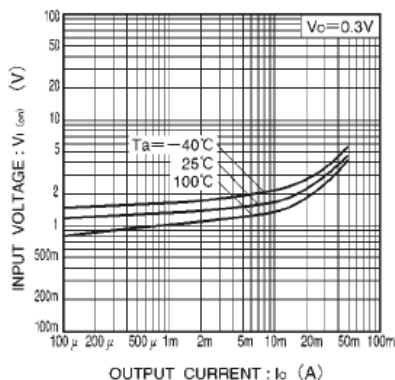

Fig.1 Input voltage vs. output current (ON characteristics)

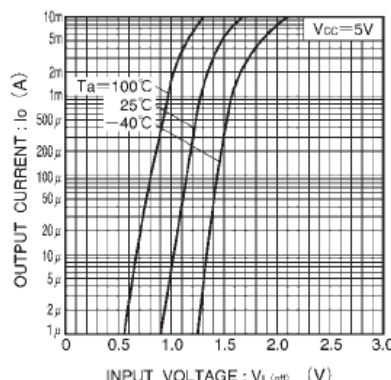

Fig.2 Output current vs. input voltage (OFF characteristics)

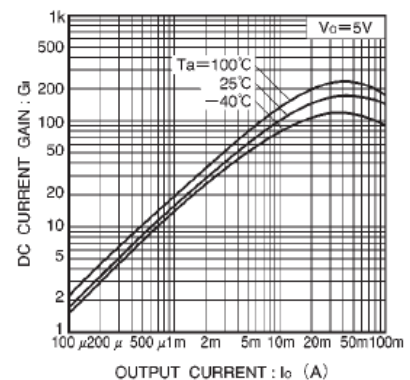

Fig.3 DC current gain vs. output current



Ratings and Characteristic Curves-DTR2 (@ $T_A = 25^\circ\text{C}$ unless otherwise specified)

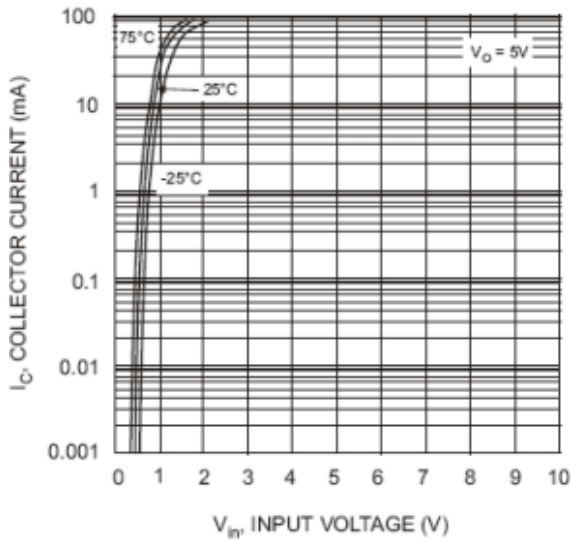

Fig. 1 Collector Current Vs. Input Voltage

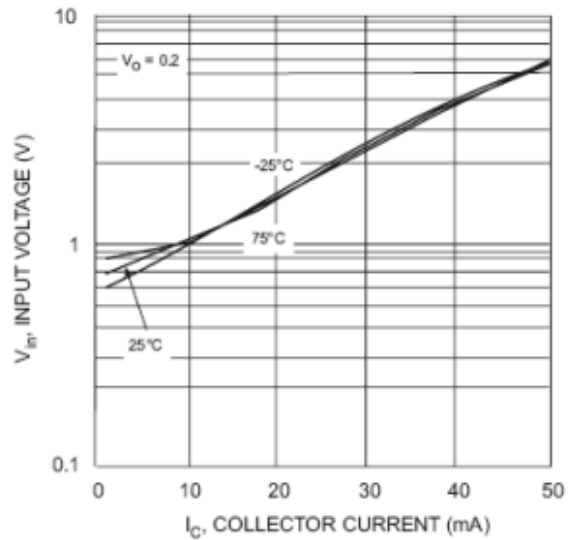

Fig. 2 Input Voltage vs. Collector Current

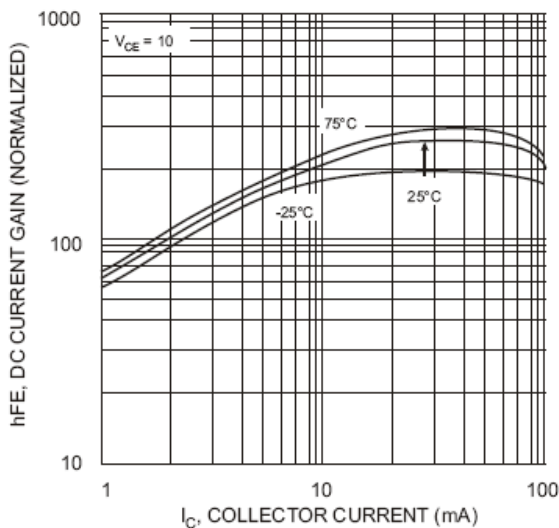

Fig. 3 DC CURRENT GAIN

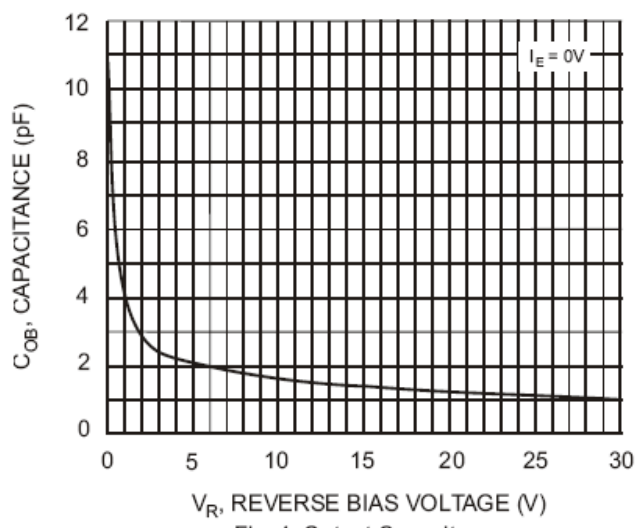

Fig. 4 Output Capacitance

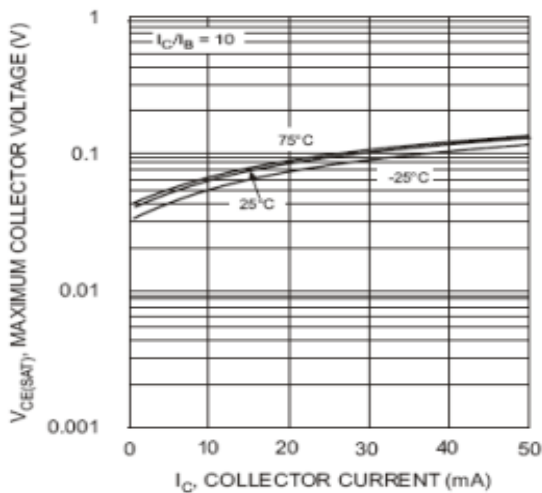
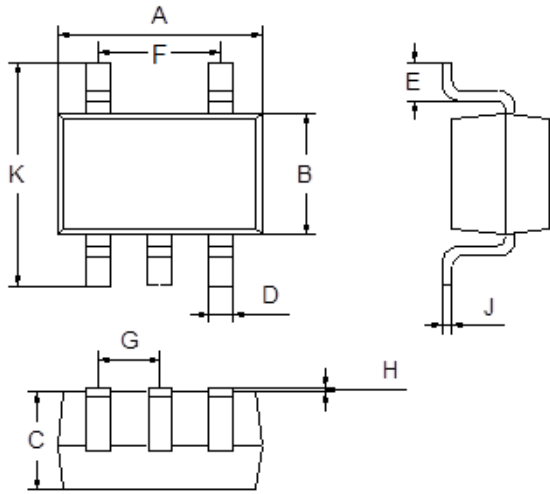

Fig. 5 $V_{CE(SAT)}$ vs. I_C



Package Outline Dimensions (Unit: mm)



SOT-353		
Dimension	Min.	Max.
A	2.00	2.20
B	1.15	1.35
C	0.85	1.05
D	0.15	0.35
E	0.25	0.40
F	1.20	1.40
G	0.60	0.70
H	0.02	0.10
J	0.05	0.15
K	2.20	2.40

Mounting Pad Layout (Unit: mm)

SOT-353

