

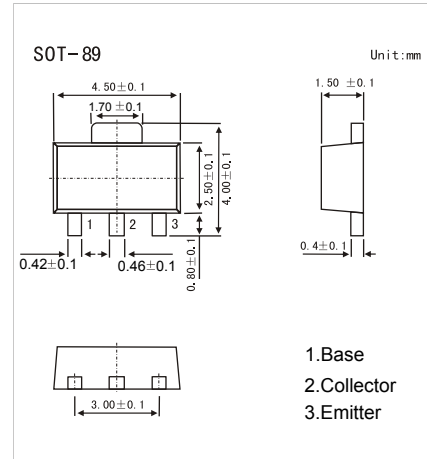

### ■ Features

- Low saturation voltage
- Collector-emitter voltage =60V
- $P_c = 2W$  (on 40X40X0.7mm ceramic board).
- Complements the 2SB1561.



### ■ Absolute Maximum Ratings $T_a = 25^\circ C$

Parameter	Symbol	Rating	Unit
Collector - Base Voltage	$V_{CB0}$	60	V
Collector - Emitter Voltage	$V_{CE0}$	60	
Emitter - Base Voltage	$V_{EB0}$	6	
Collector Current - Continuous	$I_C$	2	A
Collector Current - Pulse (Note.1)	$I_{CP}$	6	
Collector Power Dissipation (Note.2)	$P_C$	0.5	W
		2	
Junction Temperature	$T_J$	150	$^\circ C$
Storage Temperature Range	$T_{stg}$	-55 to 150	

### ■ Electrical Characteristics $T_a = 25^\circ C$

Parameter	Symbol	Test Conditions	Min	Typ	Max	Unit
Collector- base breakdown voltage	$V_{CB0}$	$I_C = 100 \mu A, I_E = 0$	60			V
Collector- emitter breakdown voltage	$V_{CE0}$	$I_C = 1 mA, I_B = 0$	60			
Emitter - base breakdown voltage	$V_{EB0}$	$I_E = 100 \mu A, I_C = 0$	6			
Collector-base cut-off current	$I_{CB0}$	$V_{CB} = 50 V, I_E = 0$			100	nA
Emitter cut-off current	$I_{EB0}$	$V_{EB} = 5 V, I_C = 0$			100	
Collector-emitter saturation voltage	$V_{CE(sat)}$	$I_C = 1 A, I_B = 50 mA$			0.35	V
Base - emitter saturation voltage	$V_{BE(sat)}$	$I_C = 1 A, I_B = 50 mA$			1.2	
DC current gain	$h_{FE(1)}$	$V_{CE} = 2 V, I_C = 500 mA$	82		390	
	$h_{FE(2)}$	$V_{CE} = 2 V, I_C = 1.5 A$	45			
Collector output capacitance	$C_{ob}$	$V_{CB} = 10 V, I_E = 0, f = 1 MHz$		21		pF
Transition frequency	$f_T$	$V_{CE} = 2 V, I_E = -500 mA, f = 100 MHz$		210		MHz

### ■ Classification of $h_{FE(1)}$

Type	2SD2391-P	2SD2391-Q	2SD2391-R
Range	82-180	120-270	180-390
Marking	DTP*	DTQ*	DTR*



### Typical Characteristics

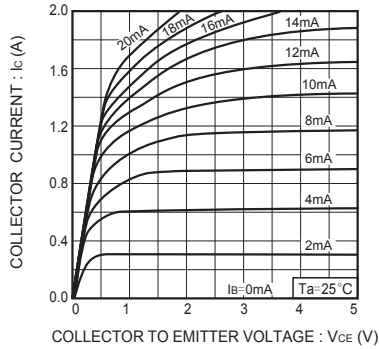

Fig.1 Grounded emitter output characteristics

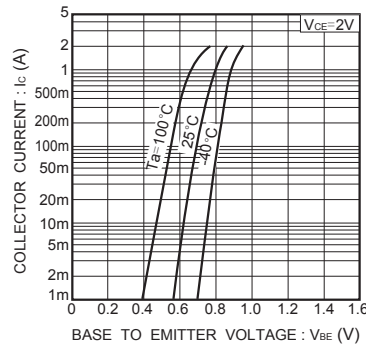

Fig.2 Grounded emitter propagation characteristics

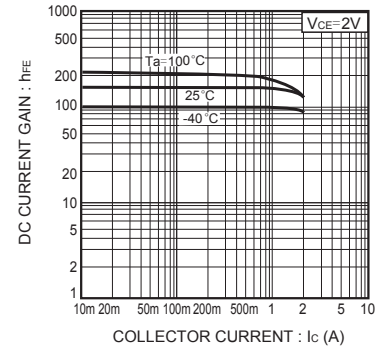

Fig.3 DC current gain vs. collector current ( 1 )

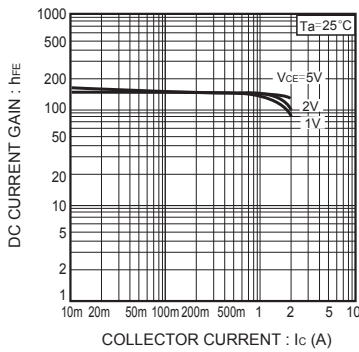

Fig.4 DC current gain vs. collector current ( 2 )

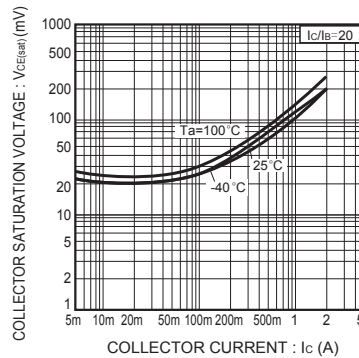

Fig.5 Collector-emitter saturation voltage vs. collector current ( 1 )

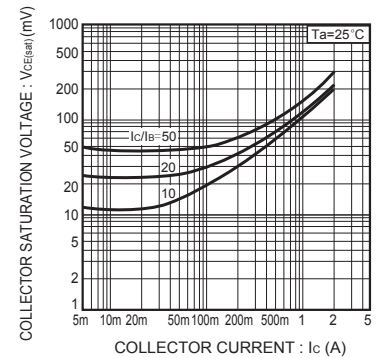

Fig.6 Collector-emitter saturation voltage vs. collector current ( 2 )

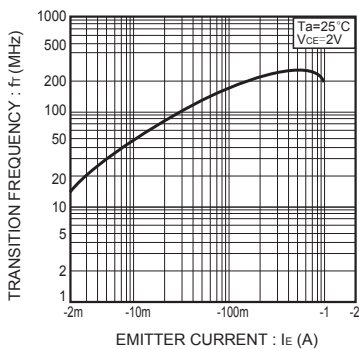

Fig.7 Gain bandwidth product vs. emitter current

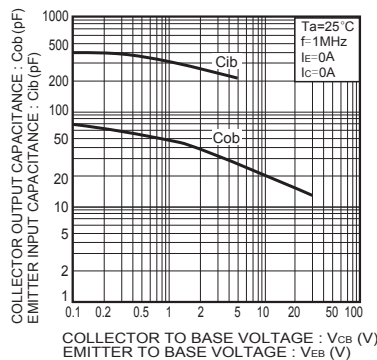

Fig.8 Input capacitance vs. voltage

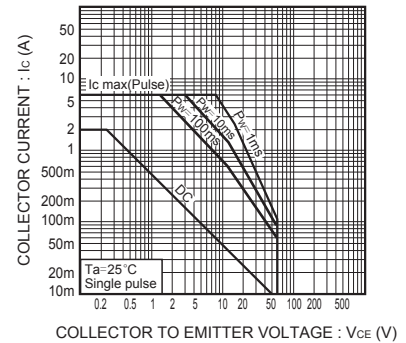

Fig.9 Safe operating area

Package	Reel	Reel Size	Box	Box Size(mm)	Carton	Carton Size(mm)
SOT -89	1000pcs	7inch	10,000pcs	203×203×195	40,000pcs	438×438×220