



FEATURES

- High collector current ($I_C = -500\text{mA}$)
- Complementary to S8050
- Excellent h_{FE} linearity

APPLICATIONS

- High collector current

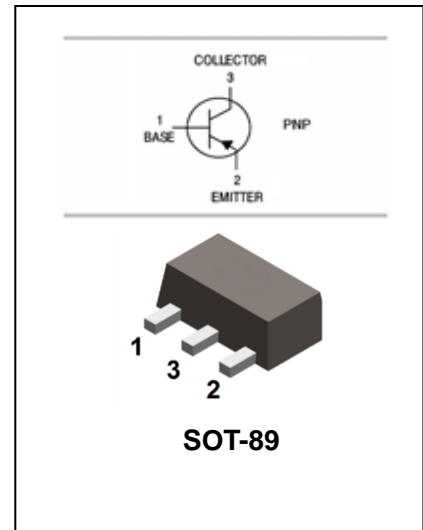

ORDERING INFORMATION

Type No.	Marking	Package Code
S8550	2TY	SOT-89

MAXIMUM RATING @ $T_a=25^\circ\text{C}$ unless otherwise specified

Symbol	Parameter	Value	Units
V_{CBO}	Collector-Base Voltage	-40	V
V_{CEO}	Collector-Emitter Voltage	-25	V
V_{EBO}	Emitter-Base Voltage	-5	V
I_C	Collector Current -Continuous	-500	mA
P_C	Collector Dissipation	750	mW
T_J, T_{STG}	Junction and Storage Temperature	-55 to +150	$^\circ\text{C}$



ELECTRICAL CHARACTERISTICS @ Ta=25°C unless otherwise specified

Parameter	Symbol	Test conditions	MIN	MAX	UNIT
Collector-base breakdown voltage	$V_{(BR)CBO}$	$I_C=-100\mu A, I_E=0$	-40		V
Collector-emitter breakdown voltage	$V_{(BR)CEO}$	$I_C=-1mA, I_B=0$	-25		V
Emitter-base breakdown voltage	$V_{(BR)EBO}$	$I_E=-100\mu A, I_C=0$	-5		V
Collector cut-off current	I_{CBO}	$V_{CB}=-40V, I_E=0$		-0.1	μA
Collector cut-off current	I_{CEO}	$V_{CE}=-20V, I_B=0$		-0.1	μA
Emitter cut-off current	I_{EBO}	$V_{EB}=-3V, I_C=0$		-0.1	μA
DC current gain	h_{FE}	$V_{CE}=-1V, I_C=-50mA$	120	350	
		$V_{CE}=-1V, I_C=-500mA$	50		
Collector-emitter saturation voltage	$V_{CE(sat)}$	$I_C=-500mA, I_B=-50mA$		-0.6	V
Base-emitter saturation voltage	$V_{BE(sat)}$	$I_C=-500mA, I_B=-50mA$		-1.2	V
Transition frequency	f_T	$V_{CE}=-6V, I_C=-20mA$ $f=30MHz$	150		MHz

CLASSIFICATION OF $h_{FE(1)}$

Rank	L	H
Range	120-200	200-350



TYPICAL CHARACTERISTICS @ Ta=25°C unless otherwise specified

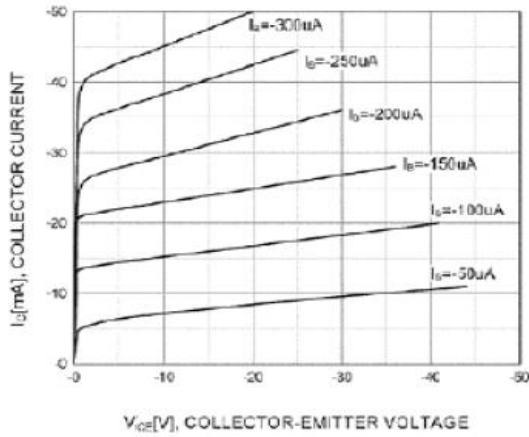

Static Characteristic

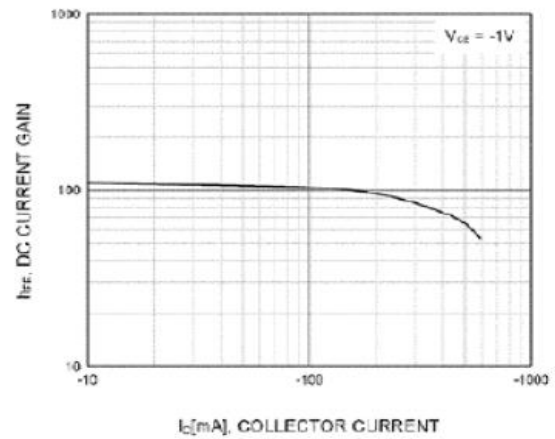

DC current Gain

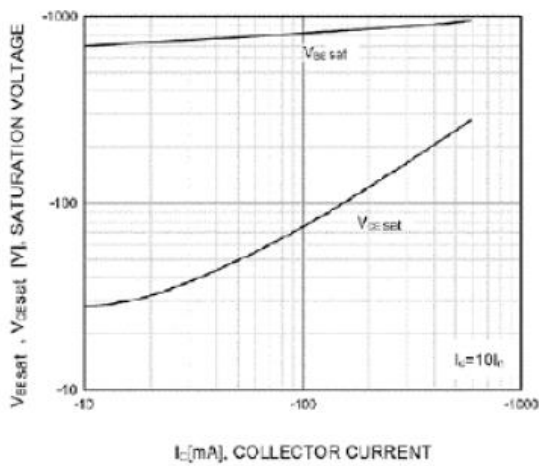

Base-Emitter Saturation Voltage
Collector-Emitter Saturation Voltage

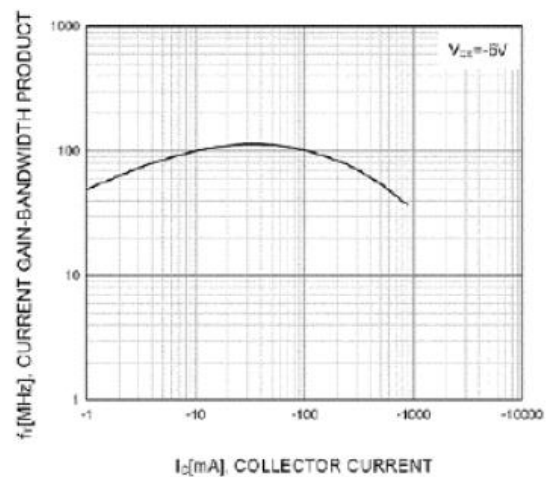

Current Gain Bandwidth Product



PACKAGE OUTLINE

Plastic surface mounted package

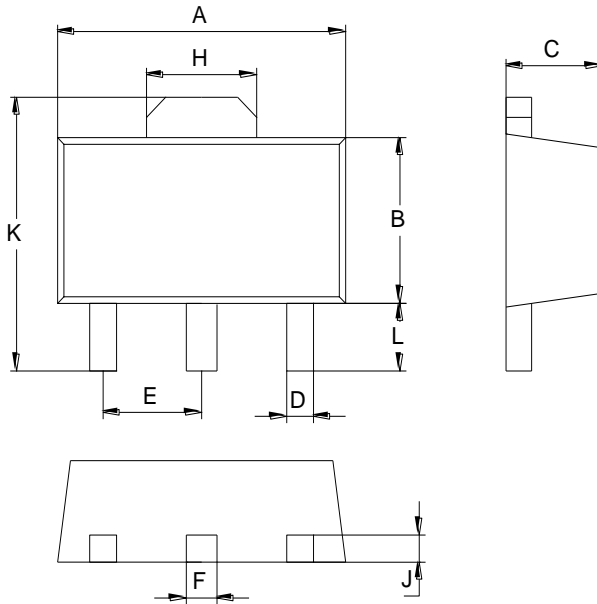

SOT-89		
Dim	Min	Max
A	4.30	4.70
B	2.25	2.65
C	1.30	1.70
D	0.30	0.50
E	1.40	1.60
F	0.38	0.58
H	1.60	1.80
J	0.30	0.50
L	0.90	1.10
K	3.95	4.35
All Dimensions in mm		

SOLDERING FOOTPRINT

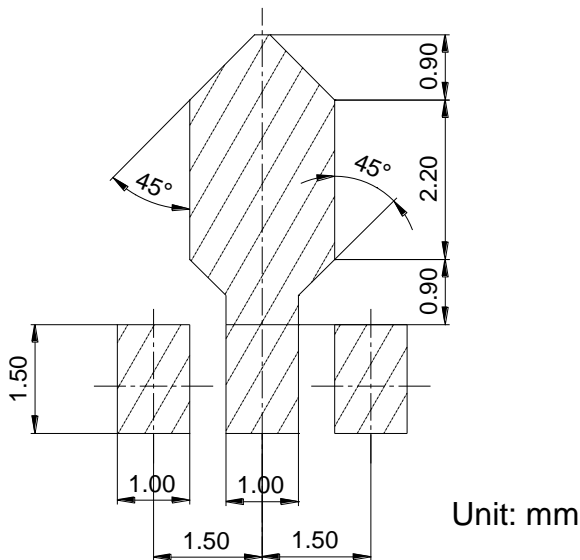

Package	Reel	Reel Size	Box	Box Size(mm)	Carton	Carton Size(mm)
SOT -89	1000pcs	7inch	10,000pcs	203×203×195	40,000pcs	438×438×220