



Breakdown Voltage: 12 to 100 V
Peak Pulse Power: 400 W

Features

- Glass passivated chip
- 400 W peak pulse power capability with a 10/1000 μ s waveform, repetitive rate (duty cycle):0.01 %
- High reliability application and automotive grade AEC Q101 qualified
- Low leakage
- Uni and Bidirectional unit
- Excellent clamping capability
- Very fast response time
- RoHS compliant

Mechanical Data

- Case: Molded plastic
- Epoxy: UL 94V-0 rate flame retardant
- Lead: Solderable per MIL-STD-750, method 2026
- Polarity: Color band denotes cathode end except Bipolar
- Mounting position: Any

SMA/ DO-214AC

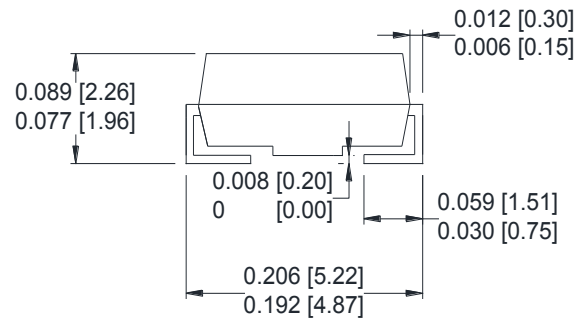
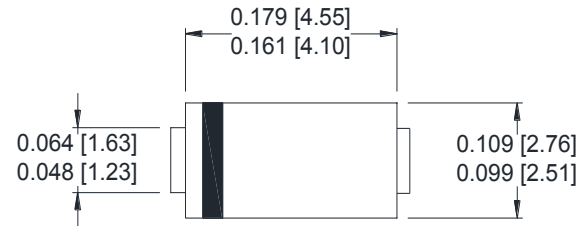

Dimensions: inch[mm]

Maximum Ratings($T_A=25^\circ\text{C}$ unless otherwise noted)

Parameter	Symbol	Value	Unit
Peak power dissipation with a 10/1000 μ s waveform ⁽¹⁾	P_{PP}	400	W
Peak pulse current with a 10/1000 μ s waveform ⁽¹⁾	I_{PP}	See Next Table	A
Power dissipation on infinite heatsink at $T_L = 75^\circ\text{C}$	P_D	1.0	W
Peak forward surge current, 8.3 ms single half sine-wave unidirectional only ⁽²⁾	I_{FSM}	40	A
Maximum instantaneous forward voltage at 25 A for unidirectional only	V_F	3.5	V
Operating junction and storage temperature range ($V_{BR} \leq 47\text{V}$)	T_J, T_{STG}	- 55 to +175	$^\circ\text{C}$
Operating junction and storage temperature range ($V_{BR} > 47\text{V}$)		- 55 to +150	$^\circ\text{C}$

Note:

(1)Non-repetitive current pulse per Fig.5 and derated above $T_A=25^\circ\text{C}$ per Fig.1

(2)Measured on 8.3 ms single half sine-wave or equivalent square wave, duty cycle = 4 pulses per minute maximum



Electrical Characteristics($T_A=25^{\circ}\text{C}$ unless otherwise noted)

Part Number (Uni)	Part Number (Bi)	Device Marking Code		Breakdown Voltage V_{BR} @ I_T			Maximum Reverse Leakage I_R @ V_{RWM} (uA)	Working Peak Reverse Voltage V_{RWM} (V)	Maximum Reverse Surge Current I_{PP} (A)	Maximum Clamping Voltage V_C @ I_{PP} (V)
		Uni	Bi	Min (V)	Max (V)	I_T (mA)				
TPSMA12A	TPSMA12CA	12AA	12CA	11.40	12.60	1	5	10.2	23.95	16.7
TPSMA13A	TPSMA13CA	13AA	13CA	12.35	13.65	1	1	11.1	21.98	18.2
TPSMA15A	TPSMA15CA	15AA	15CA	14.25	15.75	1	1	12.8	18.87	21.2
TPSMA16A	TPSMA16CA	16AA	16CA	15.20	16.80	1	1	13.6	17.78	22.5
TPSMA18A	TPSMA18CA	18AA	18CA	17.10	18.90	1	1	15.3	15.87	25.2
TPSMA20A	TPSMA20CA	20AA	20CA	19.00	21.00	1	1	17.1	14.44	27.7
TPSMA22A	TPSMA22CA	22AA	22CA	20.90	23.10	1	1	18.8	13.07	30.6
TPSMA24A	TPSMA24CA	24AA	24CA	22.80	25.20	1	1	20.5	12.05	33.2
TPSMA27A	TPSMA27CA	27AA	27CA	25.65	28.35	1	1	23.1	10.67	37.5
TPSMA30A	TPSMA30CA	30AA	30CA	28.50	31.50	1	1	25.6	9.66	41.4
TPSMA33A	TPSMA33CA	33AA	33CA	31.35	34.65	1	1	28.2	8.75	45.7
TPSMA36A	TPSMA36CA	36AA	36CA	34.20	37.80	1	1	30.8	8.02	49.9
TPSMA39A	TPSMA39CA	39AA	39CA	37.05	40.95	1	1	33.3	7.42	53.9
TPSMA43A	TPSMA43CA	43AA	43CA	40.85	45.15	1	1	36.8	6.75	59.3
TPSMA47A	TPSMA47CA	47AA	47CA	44.65	49.35	1	1	40.2	6.17	64.8
TPSMA51A	TPSMA51CA	51AA	51CA	48.45	53.55	1	1	43.6	5.71	70.1
TPSMA56A	TPSMA56CA	56AA	56CA	53.20	58.80	1	1	47.8	5.19	77.0
TPSMA62A	TPSMA62CA	62AA	62CA	58.90	65.10	1	1	53.0	4.71	85.0
TPSMA68A	TPSMA62CA	68AA	68CA	64.60	71.40	1	1	58.1	4.35	92.0
TPSMA75A	TPSMA75CA	75AA	75CA	71.25	78.75	1	1	64.1	3.88	103.0
TPSMA82A	TPSMA82CA	82AA	82CA	77.90	86.10	1	1	70.1	3.54	113.0
TPSMA91A	TPSMA91CA	91AA	91CA	86.45	95.55	1	1	77.8	3.20	125.0
TPSMA100A	TPSMA100CA	100AA	100CA	95.00	105.00	1	1	85.5	2.92	137.0

Note:

1. Add suffix 'C' or 'CA' after part number to specify Bi-directional devices



Ratings and Characteristics Curves ($T_A=25^{\circ}\text{C}$ unless otherwise noted)

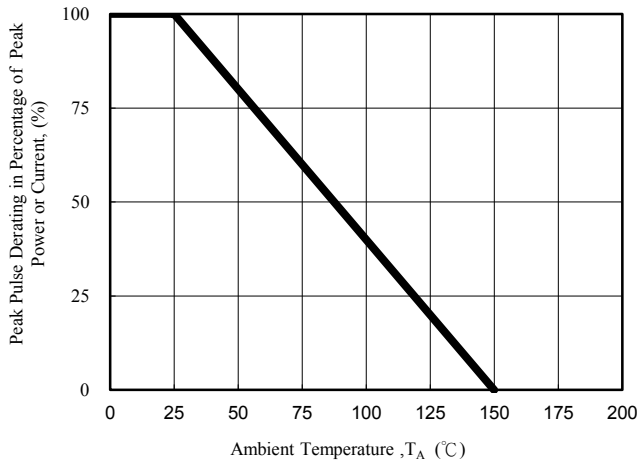

Fig. 1 - Pulse Derating Curve

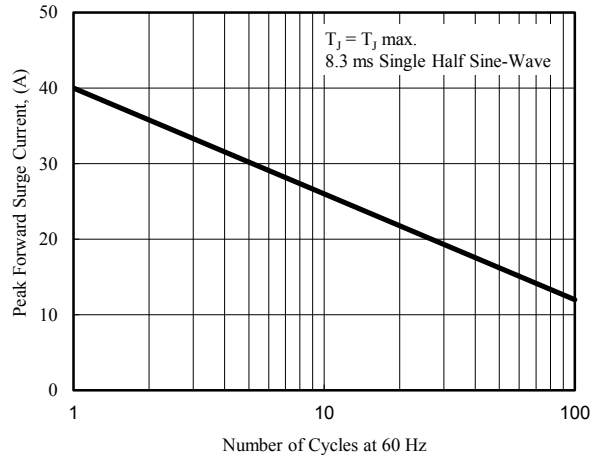

Fig. 2 - Maximum Non-Repetitive Surge Current

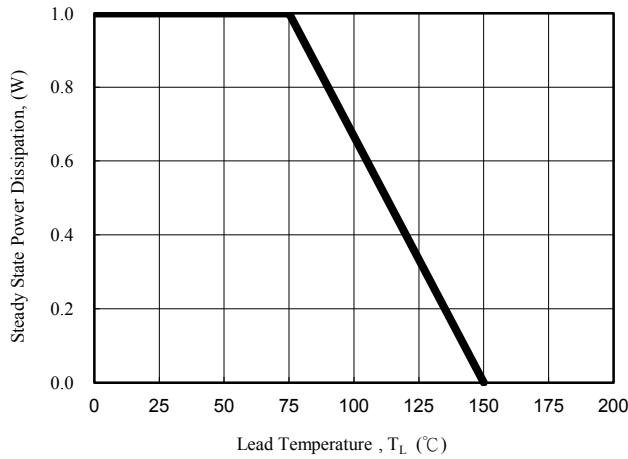

Fig. 3 - Steady State Power Derating Curve

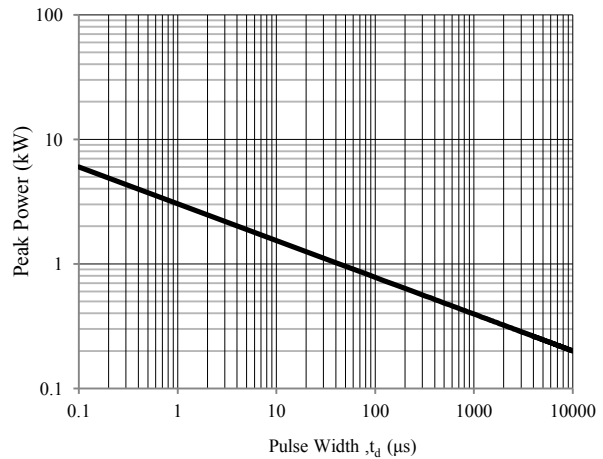

Fig. 4 - Peak Pulse Power Rating Curve

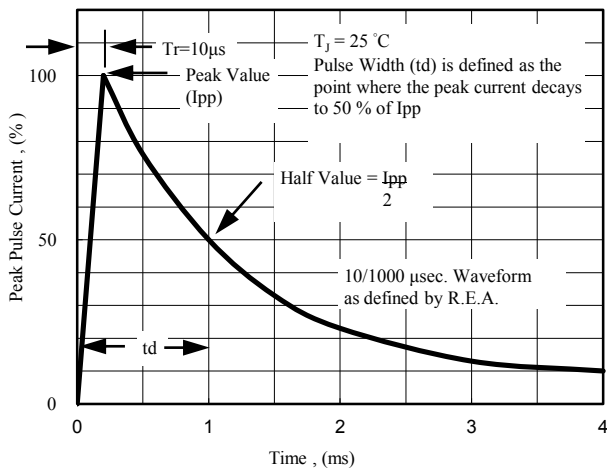

Fig. 5 - Pulse Waveform

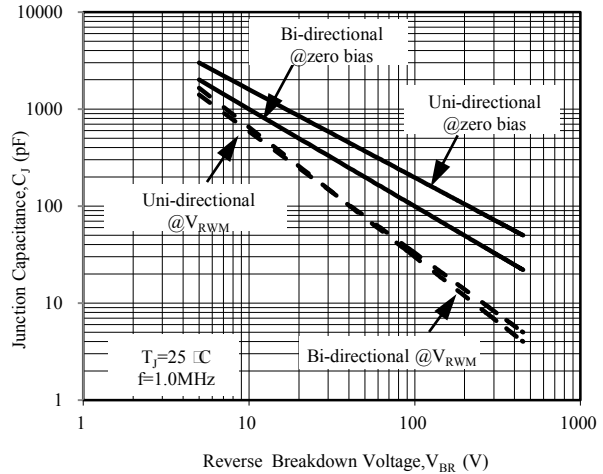

Fig. 6 - Typical Junction Capacitance

PACKAGE	SPQ/PCS	CARTON SPQ/PCS	CARTON SIZE/CM	CARTON GW/KG	CARTON NW/KG
SMA	5000/REEL	80000	36X30.6X31	12.00	11.00