



LGE3D10065F

Silicon Carbide Schottky Diode



$V_R=650V$
 $I_F = 10A (T_C=150^\circ C)$
 $Q_C = 23nC (V_R=400V)$

Features

- Zero Forward/Reverse Recovery Current
- High Blocking Voltage
- High Frequency Operation
- Positive Temperature Coefficient on V_F
- Temperature Independent Switching Behavior
- High surge current capability

Benefits

- Higher System Efficiency
- Parallel Device Convenience without thermal runaway
- Higher Temperature Application
- No Switching loss
- Hard Switching & Higher Reliability
- Environmental Protection

Applications

- Motor Drives
- Solar / Wind Inverters
- AC/DC converters
- DC/DC converters
- Uninterruptable power supplies

TO-252/DPAK

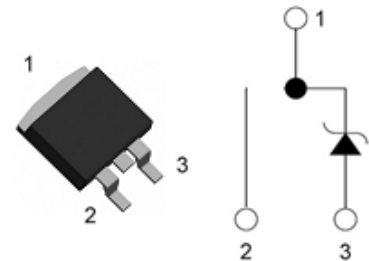

Maximum Ratings ($T_C=25^\circ C$ unless otherwise specified)

Parameter	Symbol	Test conditions	Value	Unit
Peak Repetitive Reverse Voltage	V_{RRM}		650	V
Peak Reverse Surge Voltage	V_{RSM}		650	V
DC Blocking Voltage	V_R		650	V
Continuous Forward Current	I_F	$T_C=25^\circ C$	38	A
		$T_C=135^\circ C$	16	
		$T_C=150^\circ C$	10	
Non repetitive Forward Surge Current	I_{FSM}	$T_C = 25^\circ C, t_p=10 \text{ ms, Half Sine Pulse}$	65	A
		$T_C = 110^\circ C, t_p=10 \text{ ms, Half Sine Pulse}$	55	
		$T_C = 25^\circ C, t_p=10 \mu s, \text{ Square}$	520	
Repetitive peak Forward Surge Current	I_{FRM}	$T_C = 25^\circ C, t_p=10 \text{ ms, Freq} = 0.1\text{Hz, 100 cycles, Half Sine Pulse}$	55	A
		$T_C = 110^\circ C, t_p=10 \text{ ms, Freq} = 0.1\text{Hz, 100 cycles, Half Sine Pulse}$	45	
Total power dissipation	P_D	$T_C=25^\circ C$	107	W
Operating Junction Temperature	T_J		-55 to 175	$^\circ C$
Storage Temperature	T_{STG}		-55 to 175	$^\circ C$

Stresses exceeding those listed in the Maximum Ratings table may damage the device. If any of these limits are exceeded, device functionality should not be assumed, damage may occur and reliability may be affected.



Electrical Characteristics

Parameter	Symbol	Test conditions	Min	Typ	Max	Unit
DC Blocking Voltage	V_{DC}	$I_R = 250\mu A, T_J = 25^\circ C$	650			V
Forward Voltage	V_F	$I_F = 10A, T_J = 25^\circ C$		1.45	1.8	V
		$I_F = 10A, T_J = 125^\circ C$		1.55		
		$I_F = 10A, T_J = 175^\circ C$		1.7		V
Reverse Current	I_R	$V_R = 650V, T_J = 25^\circ C$		12	80	μA
		$V_R = 650V, T_J = 125^\circ C$		68		μA
		$V_R = 650V, T_J = 175^\circ C$		190		μA
Total Capacitive Charge	Q_C	$V_R = 400V, I_F = 10A, di/dt = 200A/\mu s, T_J = 25^\circ C$		23		nC
Total Capacitance	C	$V_R = 1V, T_J = 25^\circ C, Freq = 1MHz$		380		pF
		$V_R = 300V, T_J = 25^\circ C, Freq = 1MHz$		38		
		$V_R = 550V, T_J = 25^\circ C, Freq = 1MHz$		31		

Note: This is a majority carrier diode, so there is no reverse recovery charge

Thermal Characteristics

Parameter	Symbol	Condition	Min	Typ	Max	Unit
Thermal Resistance	$R_{th(j-c)}$	junction-case		1.4		$^\circ C/W$



Typical Electrical Curves

Figure 1. Forward Characteristics

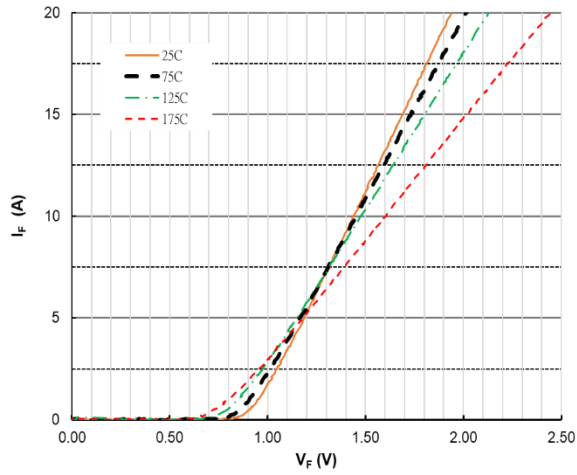

Figure 2. Forward Characteristics

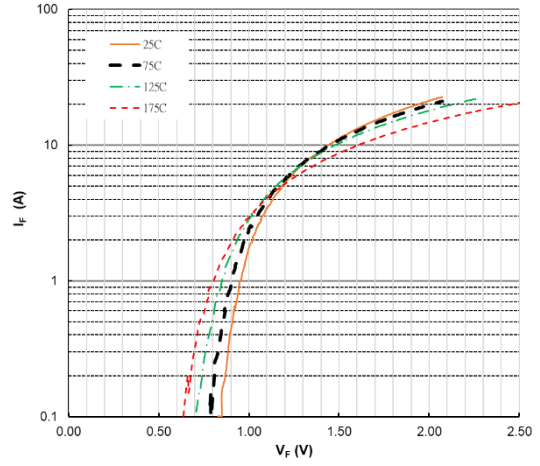

Figure 3. Reverse Characteristics

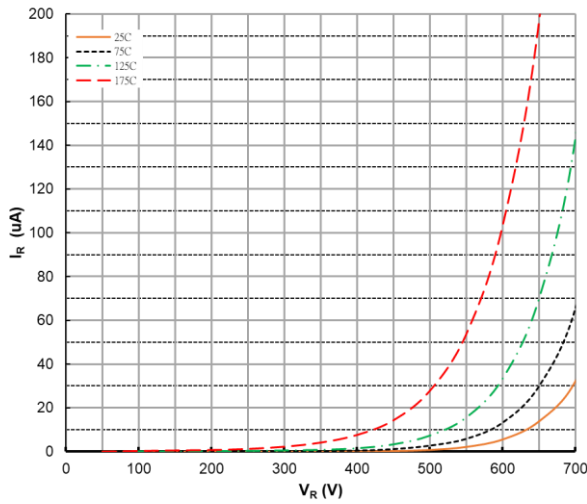

Figure 4. Power Derating

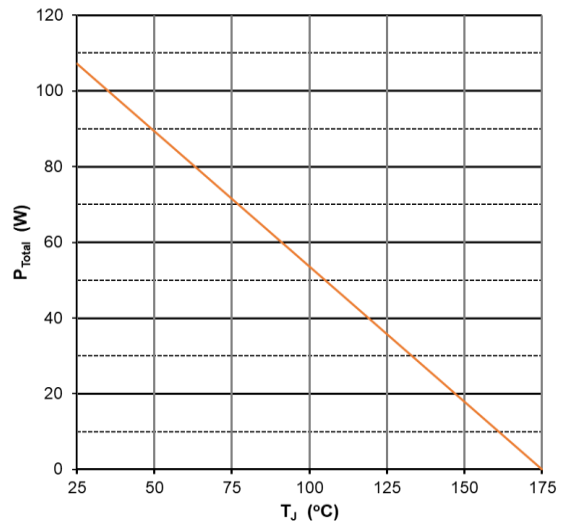

Figure 5. Capacitance vs Reverse Voltage

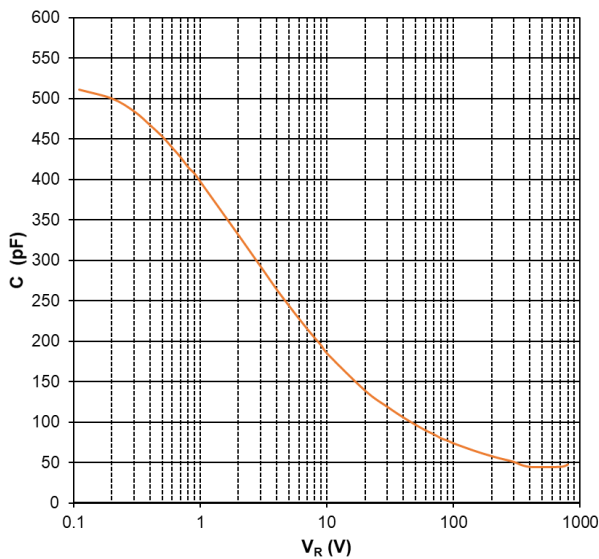
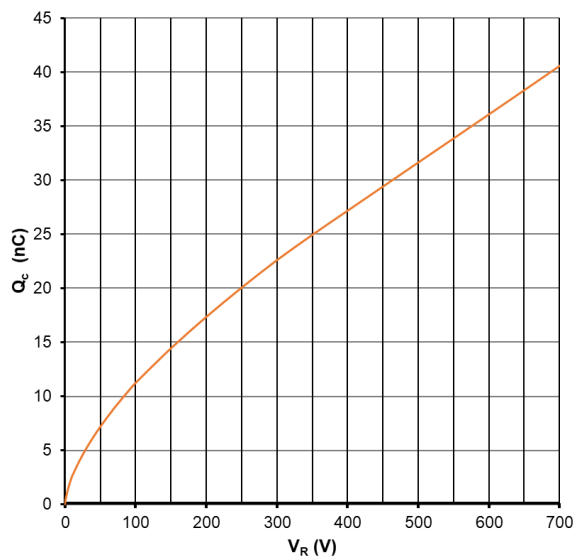
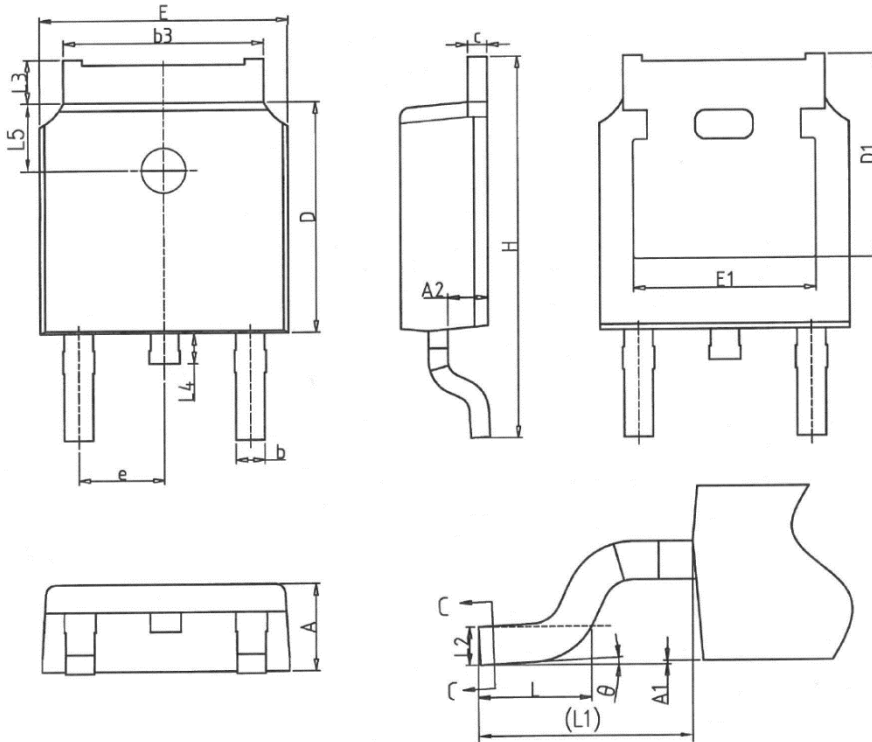

Figure 6. Recovery Charge vs Reverse Voltage



Package Dimensions

(TO-252/DPAK Package)



Symbol	mm		
	MIN	NOM	MAX
A	2.20	2.30	2.38
A1	0.00	-	0.20
A2	0.97	1.07	1.17
b	0.68	0.78	0.90
b3	5.20	5.33	5.46
c	0.43	0.53	0.61
D	5.98	6.10	6.22
D1	5.30 REF		
E	6.40	6.60	6.73
E1	4.63	-	-
e	2.286 BSC		
H	9.40	10.10	10.50
L	1.38	1.50	1.75
L1	2.90 REF		
L2	0.51 BSC		
L3	0.88	-	1.28
L4	0.50	-	1.00
L5	1.65	1.80	1.95
θ	0°	-	8°

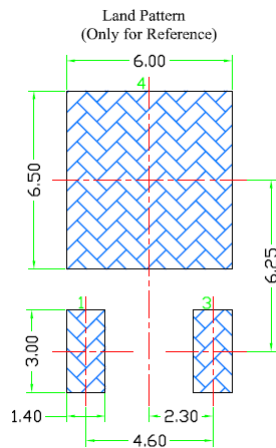

Note:

- All dimensions are in mm and refer to JEDEC standard TO-252 AA, do not include mold flash or protrusions

Ordering Information

Part Number	Package	Packing	Marking	Base Quantity
LGE3D10065F	TO-252/DPAK	2500pcs / Tape & Reel	LGE3D10065F	2500PCS